

# LC EX

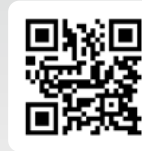

[net.grundfos.com/  
qr/i/99381576](https://net.grundfos.com/qr/i/99381576)



[net.grundfos.com/  
qr/i/99480674](https://net.grundfos.com/qr/i/99480674)

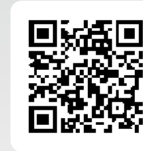

[net.grundfos.com/  
qr/i/99381670](https://net.grundfos.com/qr/i/99381670)



[net.grundfos.com/  
qr/i/99480978](https://net.grundfos.com/qr/i/99480978)

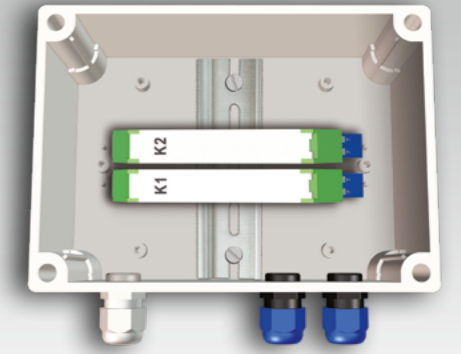
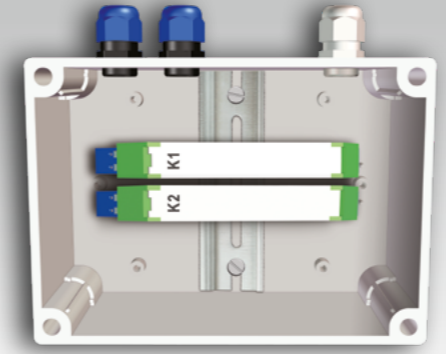
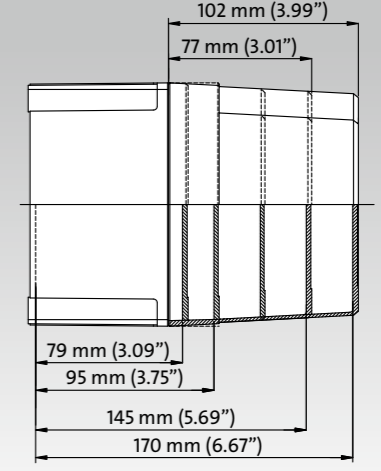
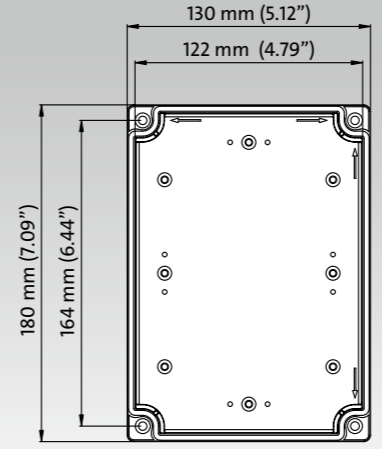
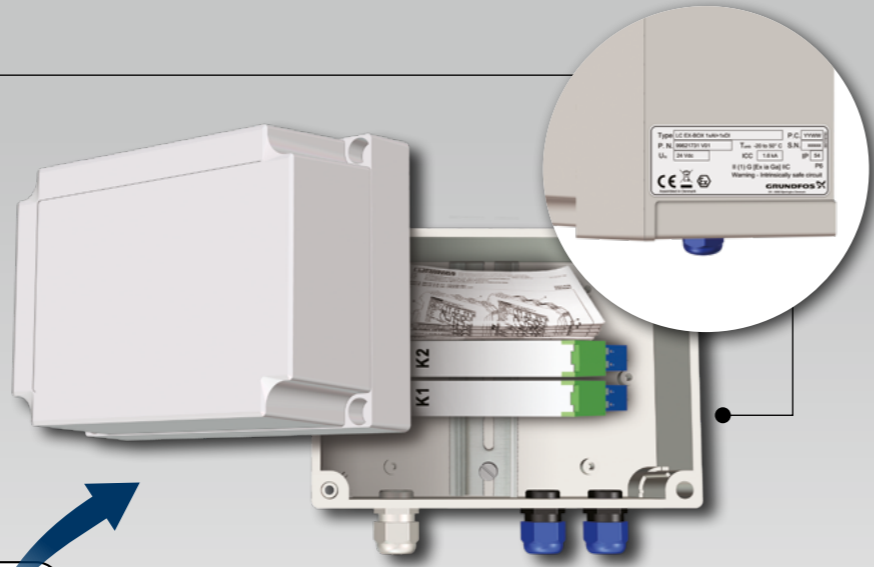
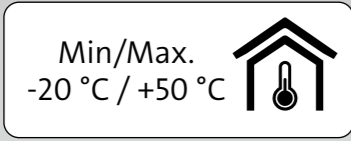
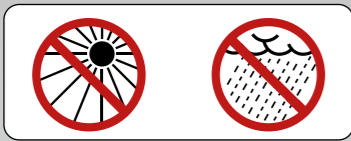
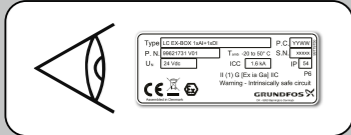



LC EX-Box 99621732 4 x digital  
LC 231 / LC 241

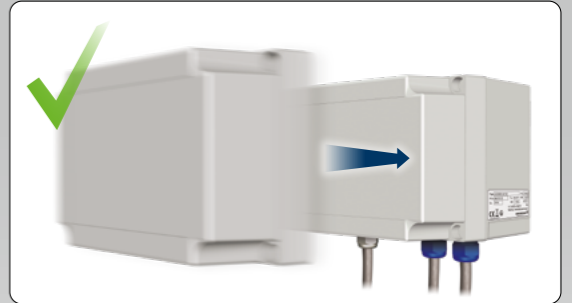
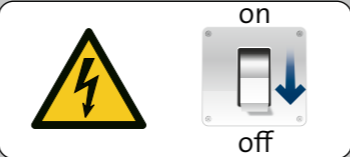

LC 231

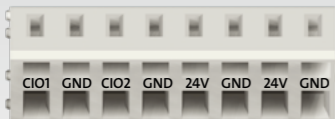
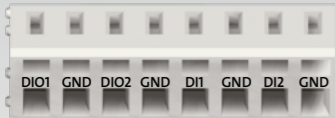

LC 241

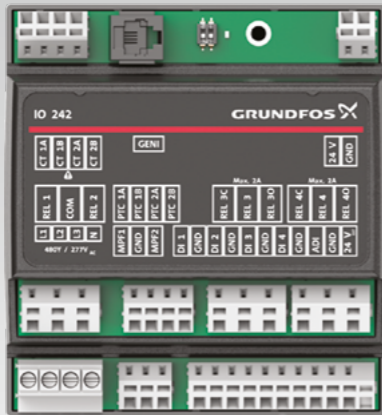

LC EX-BOX 4xDI					
LC 231 terminal	LC 241 terminal	Wire name	Wire no.	Terminal	Sensor
24 V	24 V	24 V	1	24 V	
GND	GND	24 V GND	2	24 V GND	
DIO1	DI2	Digital 1	3	K1-4.1	Stop level
GND	GND	Digital 1 GND	4	K1-4.2	Stop level
DIO2	DI3	Digital 2	5	K1-5.1	Start P1
GND	GND	Digital 2 GND	6	K1-5.2	Start P1
DI1	DI4	Digital 3	7	K2-4.1	Start P2
GND	GND	Digital 3 GND	8	K2-4.2	Start P2
DI2	ADI	Digital 4	9	K2-5.1	High level
GND	GND	Digital 4 GND	10	K2-5.2	High level

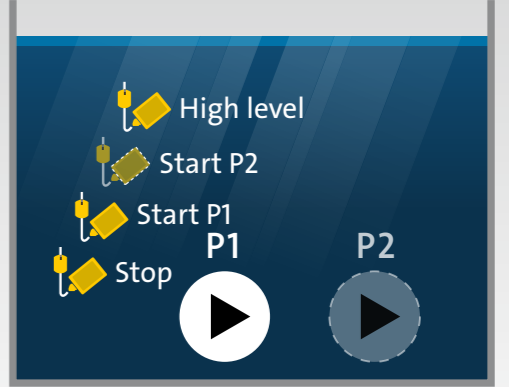
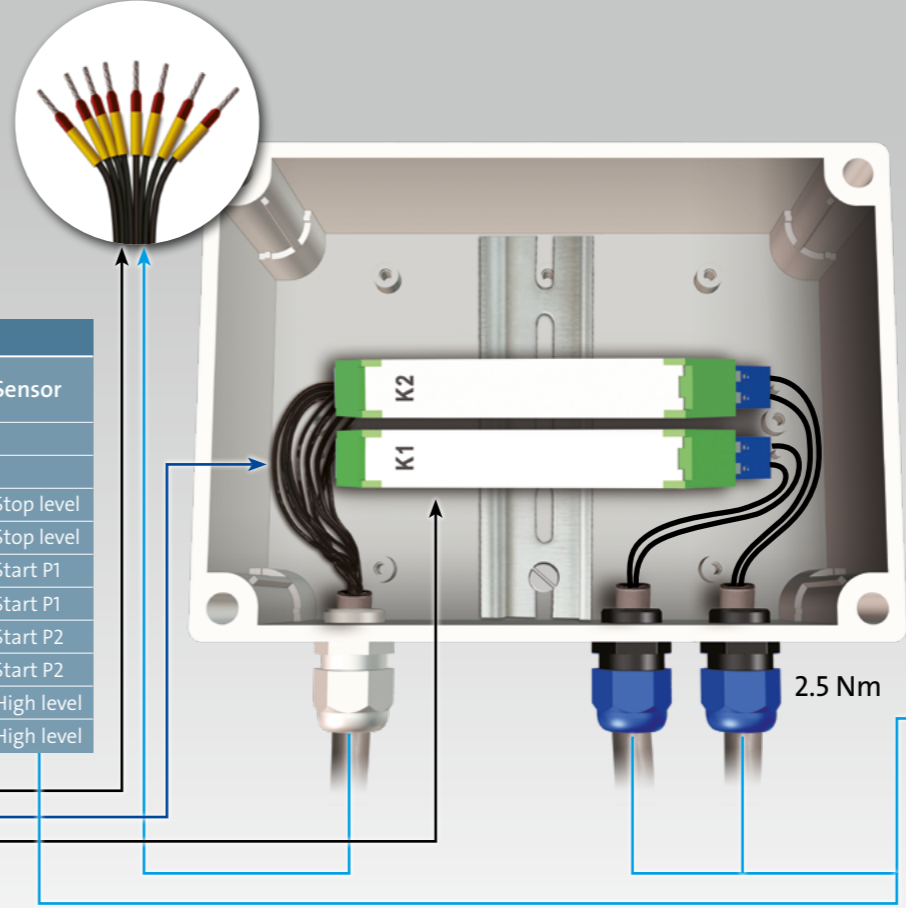



LC EX-Box 99621731 1 x digital / 1 x analog  
LC 231 / LC 241

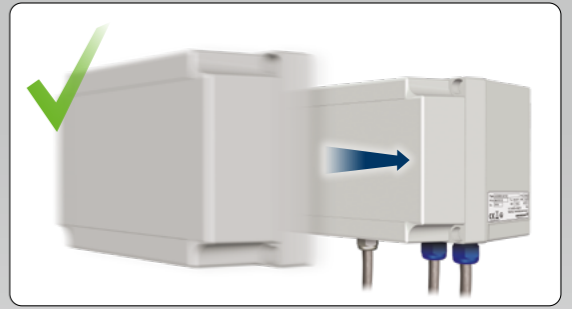
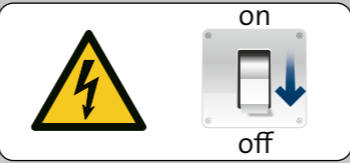

LC 231

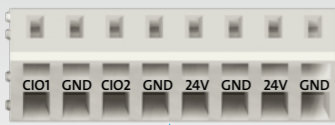

LC 241

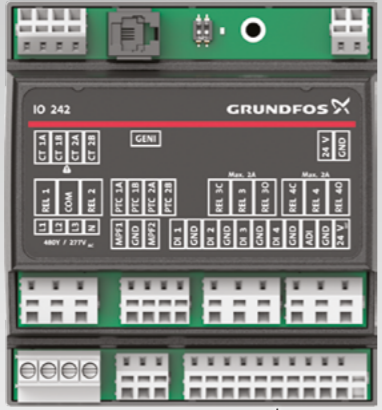

LC EX-BOX 1xAI + 1xDI					
LC 231 terminal	LC 241 terminal	Wire name	Wire no.	Terminal	Sensor
24 V	24 V	24 V	1	24 V	
GND	GND	24 V GND	2	24 V GND	
DI2	DI4	Digital 1	3	K1-4.1	High level
GND	GND	Digital 1 GND	4	K1-4.2	High level
CIO1	ADI	Analog 1	5	K2-4.1	Analog pressure transmitter
GND	GND	Analog 1 GND	6	K2-4.2	Analog pressure transmitter, GND

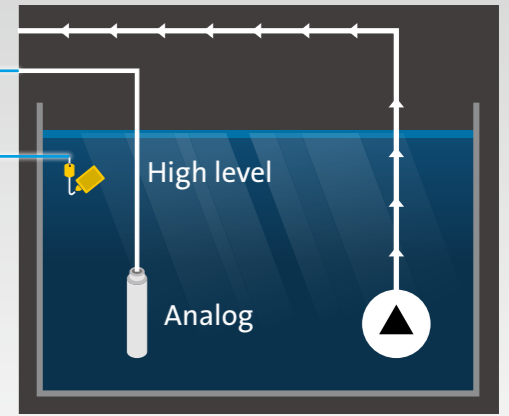
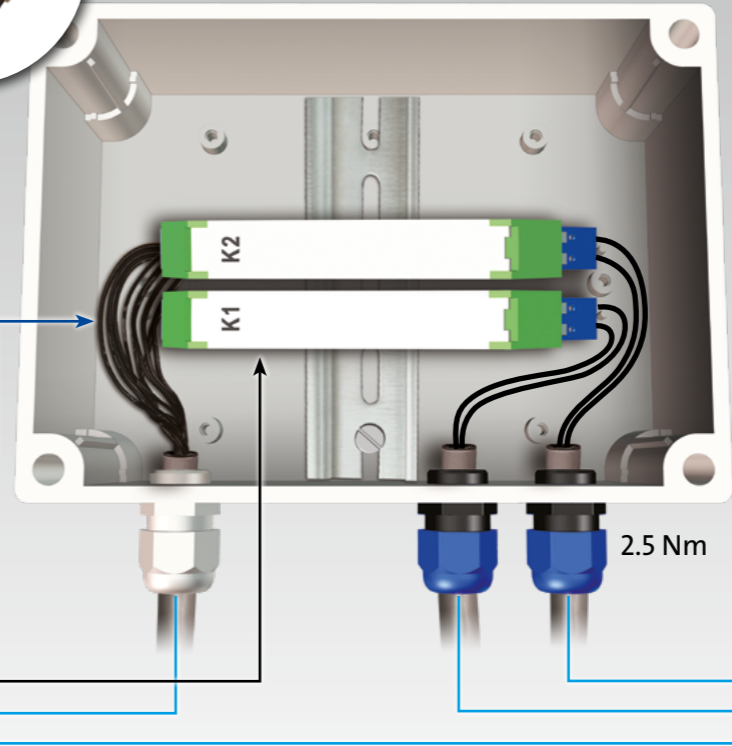



**GB:** The crossed-out wheelee bin symbol on a product means that it must be disposed of separately from household waste. When a product marked with this symbol reaches its end of life, take it to a collection point designated by the local waste disposal authorities. The separate collection and recycling of such products will help protect the environment and human health.



**BG:** Зачеркнатият символ на кофа за отпадъци върху продукта означава, че той трябва да бъде изхвърлен отделно от битовите отпадъци. Когато маркираният с този символ продукт достигне края на експлоатационния си живот, отнесете го в пункт за събиране на такива отпадъци, посочен от местните организации за третиране на отпадъци. Разделното събиране и рециклиране на подобни продукти ще спомогне за опазването на околната среда и здравето на хората.



**ES:** El símbolo con el contenedor tachado que aparece en el producto significa que este no debe eliminarse junto con la basura doméstica. Cuando un producto marcado con este símbolo alcance el final de su vida útil, debe llevarse a un punto de recogida selectiva designado por las autoridades locales competentes en materia de gestión de residuos. La recogida selectiva y el reciclaje de este tipo de productos contribuyen a proteger el medio ambiente y la salud de las personas.



**HU:** Az áthúzott kuka jel egy termékén azt jelenti, hogy ezt a háztartási hulladéktól elválasztva, külön kell kezelni. Amikor egy ilyen jellel ellátott termék életciklusának végéhez ér, vigye azt a helyi hulladékkezelő intézmény által kijelölt gyűjtőhelyre. Az ilyen termékek elkülönített gyűjtése és újrahasznosítása segít megővni a környezetet és az emberek egészségét.



**IT:** Il simbolo del bidone della spazzatura sbarrato sul prodotto indica che deve essere smaltito separatamente dai rifiuti domestici. Quando un prodotto contrassegnato con questo simbolo raggiunge la fine della vita utile, consegnarlo presso un punto di raccolta designato dagli enti locali per lo smaltimento. La raccolta differenziata ed il riciclo di tali prodotti consentono di tutelare la salute umana e l'ambiente.



**RO:** Simbolul de pebelă întretăiată aflată pe un produs denotă faptul că acesta trebuie depus la deșeurii separat de gunoier menajer. Când un produs cu acest simbol ajunge la sfârșitul duratei de viață, acesta trebuie dus la un punct de colectare desemnat de către autoritățile locale de administrare a deșeurilor. Colectarea și reciclarea separate ale acestor produse vor ajuta la protejerea mediului înconjurător și a sănătății umane.



**SE:** Symbolen med en överkorsad soptunna på en produkt betyder att den inte får kasseras som hushållsavfall. När en produkt märkt med denna symbol är trasig och inte reparierbar skall den inlämnas enligt anvisningar från lokala avfallshanteringsmyndigheter. Separat insamling och återvinning av sådana produkter hjälper till att skydda miljön och människors hälsa.

## Declaration of conformity

### GB: EU declaration of conformity

We, Grundfos, declare under our sole responsibility that the products LC EX-BOX 1xAI + 1xDI, LC EX-BOX 4xDI, to which the declaration below relates, are in conformity with the Council Directives listed below on the approximation of the laws of the EU member states.

### BG: Декларация за съответствие на ЕО

Ние, фирма Grundfos, заявяваме с пълна отговорност, че продуктите LC EX-BOX 1xAI + 1xDI, LC EX-BOX 4xDI, за които се отнася настоящата декларация, отговарят на следните директиви на Съвета за уеднаквяване на правните разпоредби на държавите-членки на ЕО.

### CZ: Prohlášení o shodě EU

My firma Grundfos prohlašujeme na svou plnou odpovědnost, že výrobky LC EX-BOX 1xAI + 1xDI, LC EX-BOX 4xDI, na které se toto prohlášení vztahuje, jsou v souladu s níže uvedenými ustanoveními směrnice Rady pro sblížení právních předpisů členských států Evropského společenství.

### DE: EU-Konformitätserklärung

Wir, Grundfos, erklären in alleiniger Verantwortung, dass die Produkte LC EX-BOX 1xAI + 1xDI, LC EX-BOX 4xDI, auf die sich diese Erklärung bezieht, mit den folgenden Richtlinien des Rates zur Angleichung der Rechtsvorschriften der EU-Mitgliedstaaten übereinstimmen.

### DK: EU-overensstemmelseserklæring

Vi, Grundfos, erklærer under ansvar at produkterne LC EX-BOX 1xAI + 1xDI, LC EX-BOX 4xDI som erklæringen nedenfor omhandler, er i overensstemmelse med Rådets direktiver der er nævnt nedenfor, om indbyrdes tilnærmelse til EU-medlemsstaternes lovgivning.

### EE: EÜ vastavusdeklaratsioon

Meie, Grundfos, kinnitame ja kanname ainuisikulist vastutust selle eest, et toode LC EX-BOX 1xAI + 1xDI, LC EX-BOX 4xDI, mille kohta all olev deklaratsioon käib, on kooskõlas Nõukogu Direktiividega, mis on nimetatud all pool vastavalt vastuvõetud õigusaktidele ühtlustamise kohta EÜ liikmesriikides.

### ES: Declaración de conformidad de la UE

Grundfos declara, bajo su exclusiva responsabilidad, que los productos LC EX-BOX 1xAI + 1xDI, LC EX-BOX 4xDI a los que hace referencia la siguiente declaración cumplen lo establecido por las siguientes Directivas del Consejo sobre la aproximación de las legislaciones de los Estados miembros de la UE.

### FI: EU-vaatimustenmukaisuusvakuutus

Grundfos vakuuttaa omalla vastuullaan, että tuotteet LC EX-BOX 1xAI + 1xDI, LC EX-BOX 4xDI, joita tämä vakuutus koskee, ovat EU:n jäsenvaltioiden lainsäädännön lähentämiseen tähtäävien Euroopan neuvoston direktiivien vaatimusten mukaisia seuraavasti.

### FR: Déclaration de conformité UE

Nous, Grundfos, déclarons sous notre seule responsabilité, que les produits LC EX-BOX 1xAI + 1xDI, LC EX-BOX 4xDI, auxquels se réfère cette déclaration, sont conformes aux Directives du Conseil concernant le rapprochement des législations des États membres UE relatives aux normes énoncées ci-dessous.

### GR: Δήλωση συμμόρφωσης ΕΕ

Εμείς, η Grundfos, δηλώνουμε με αποκλειστικά δική μας ευθύνη ότι τα προϊόντα LC EX-BOX 1xAI + 1xDI, LC EX-BOX 4xDI, στα οποία αναφέρεται η παρακάτω δήλωση, συμμορφώνονται με τις παρακάτω Οδηγίες του Συμβουλίου περί προσέγγισης των νομοθεσιών των κρατών μελών της ΕΕ.

### HR: EU deklaracija sukladnosti

Mi, Grundfos, izjavljujemo s punom odgovornošću da su proizvodi LC EX-BOX 1xAI + 1xDI, LC EX-BOX 4xDI, na koja se izjava odnosi u nastavku, u skladu s dolje navedenim direktivama Vijeća o usklađivanju zakona država članica EU-a.

### HU: EU megfeleléségi nyilatkozat

Mi, a Grundfos vállalat, teljes felelősséggel kijelentjük, hogy a(z) LC EX-BOX 1xAI + 1xDI, LC EX-BOX 4xDI termékek, amelyek az alábbi nyilatkozat vonatkozik, megfelelnek az Európai Unió tagállamainak jogi irányelveit összehangoló tanács alábbi előírásainak.

### IT: Dichiarazione di conformità UE

Grundfos dichiara sotto la sua esclusiva responsabilità che i prodotti LC EX-BOX 1xAI + 1xDI, LC EX-BOX 4xDI, ai quale si riferisce questa dichiarazione, sono conformi alle seguenti direttive del Consiglio riguardanti il riavvicinamento delle legislazioni degli Stati membri UE.

### LT: ES atitikties deklaracija

Mes, Grundfos, su visa atsakomybe pareiškiame, kad produktai LC EX-BOX 1xAI + 1xDI, LC EX-BOX 4xDI, kuriems skirta ši deklaracija, atitinka žemiau nurodytas Tarybos Direktyvas dėl ES šalių narių įstatymų suderinimo.

### LV: ES atbilstības deklarācija

Sabiedrība Grundfos ar pilnu atbildību paziņo, ka produkti LC EX-BOX 1xAI + 1xDI, LC EX-BOX 4xDI, uz kuru attiecas tālāk redzamā deklarācija, atbilst tālāk norādītajām Padomes direktīvām par ES dalībvalstu normatīvo aktu tuvināšanu.

### NL: EU-conformiteitsverklaring

Wij, Grundfos, verklaren geheel onder eigen verantwoordelijkheid dat de producten LC EX-BOX 1xAI + 1xDI, LC EX-BOX 4xDI, waartoe de onderstaande verklaring betrekking heeft, in overeenstemming zijn met de onderstaande Richtlijnen van de Raad inzake de onderlinge aanpassing van de wetgeving van de EU-lidstaten.

### PL: Deklaracja zgodności UE

My, Grundfos, oświadczamy z pełną odpowiedzialnością, że nasze produkty LC EX-BOX 1xAI + 1xDI, LC EX-BOX 4xDI, których deklaracja niniejsza dotyczy, są zgodne z następującymi dyrektywami Rady w sprawie zbliżenia przepisów prawnych państw członkowskich.

### PT: Declaração de conformidade UE

A Grundfos declara sob sua única responsabilidade que os produtos LC EX-BOX 1xAI + 1xDI, LC EX-BOX 4xDI, aos quais diz respeito a declaração abaixo, estão em conformidade com as Directivas do Conselho sobre a aproximação das legislações dos Estados Membros da UE.

**RO: Declarația de conformitate UE**

Noi Grundfos declarăm pe propria răspundere că produsele LC EX-BOX 1xAI + 1xDI, LC EX-BOX 4xDI, la care se referă această declarație, sunt în conformitate cu Directivile de Consiliu specificate mai jos privind armonizarea legilor statelor membre UE.

**RS: Deklaracija o usklađenosti EU**

Mi, kompanija Grundfos, izjavljujemo pod punom vlastitom odgovornošću da je proizvod LC EX-BOX 1xAI + 1xDI, LC EX-BOX 4xDI, na koji se odnosi deklaracija ispod, u skladu sa dole prikazanim direktivama Saveta za usklađivanje zakona država članica EU.

**RU: Декларация о соответствии нормам ЕС**

Мы, компания Grundfos, со всей ответственностью заявляем, что изделия LC EX-BOX 1xAI + 1xDI, LC EX-BOX 4xDI, к которым относится нижеприведённая декларация, соответствуют нижеприведённым Директивам Совета Евросоюза о тождественности законов стран-членов ЕС.

**SE: EU-försäkran om överensstämmelse**

Vi, Grundfos, försäkrar under ansvar att produkterna LC EX-BOX 1xAI + 1xDI, LC EX-BOX 4xDI, som omfattas av nedanstående försäkran, är i överensstämmelse med de rådsdirektiv om inbördes närmande till EU-medlemsstaternas lagstiftning som listas nedan.

**SI: Izjava o skladnosti EU**

V Grundfosu s polno odgovornostjo izjavljamo, da je izdelek LC EX-BOX 1xAI + 1xDI, LC EX-BOX 4xDI, na katerega se spodnja izjava nanaša, v skladu s spodnjimi direktivami Sveta o približevanju zakonodaje za izenačevanje pravnih predpisov držav članic EU.

**TR: AB uygunluk bildirgesi**

Grundfos olarak, aşağıdaki bildirim konusu olan LC EX-BOX 1xAI + 1xDI, LC EX-BOX 4xDI ürünlerinin, AB Üye ülkelerinin direktiflerinin yakınlaştırılmasıyla ilgili durumun aşağıdaki Konsey Direktifleriyle uyumlu olduğunu ve bununla ilgili olarak tüm sorumluluğun bize ait olduğunu beyan ederiz.

**UA: Декларація відповідності директивам EU**

Ми, компанія Grundfos, під нашу одноосібну відповідальність заявляємо, що вироби LC EX-BOX 1xAI + 1xDI, LC EX-BOX 4xDI, до яких відноситься нижченаведена декларація, відповідають директивам EU, переліченим нижче, щодо тотожності законів країн-членів ЄС.

**CN: 欧盟符合性声明**

我们，格兰富，在我们的全权责任下声明，产品LC EX-BOX 1xAI + 1xDI, LC EX-BOX 4xDI系列，其制造和性能完全符合以下所列欧盟委员会指令。

**(EU) :إقرار مطابقة الاتحاد الأوروبي (EU)**

نقر نحن، جرونډفوس، بمقتضى مسؤوليتنا الفردية بأن نقتضى LC LC EX-BOX و EX-BOX 1xAI + 1xDI 4xDI، اللذين يختص بهما الإقرار أثناءه، يكونان مطابقتين لتوجيهات المجلس المذكورة أثناءه بشأن التقريب بين قوانين الدول أعضاء الاتحاد الأوروبي (EU).

EMC Directive (2014/30/EU)

- Standards used:  
EN 61000-6-2:2005  
EN 61000-6-4:2007 + A1:2011

RoHS Directives (2011/65/EU and 2015/863/EU)

- Standards used:  
EN 50581:2012

ATEX Directive (2014/30/EU)

For further details see the Phoenix leaflets delivered together with the product.

This EU declaration of conformity is only valid when published as part of the Grundfos Quick guide instructions (publication number 99725666).

Bjerringbro, 20/01/2020

Tommy Enevoldsen  
Senior Manager

Grundfos Holding A/S  
Poul Due Jensens Vej 7  
DK-8850 Bjerringbro, Denmark

Manufacturer or person empowered to sign  
the EU declaration of conformity.

Installation date: \_\_\_\_\_

Installer:

---

---

---

---

---

---

---

99725666 06.2022

ECM: 1342641

**GRUNDFOS Holding A/S**  
Poul Due Jensens Vej 7  
DK-8850 Bjerringbro  
Tel: +45 87 50 14 00  
[www.grundfos.com](http://www.grundfos.com)

**GRUNDFOS** 