



MAGNA1

VALID FROM MODEL C

Further product
documentation



net.grundfos.com/qr/i/99209952

be
think
innovate

GRUNDFOS 



MAGNA1



MAGNA1 D

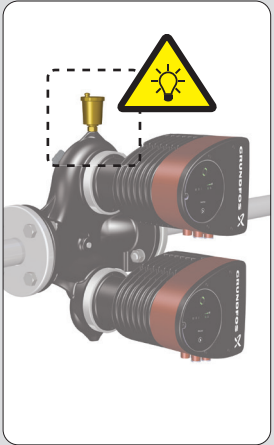



Min. / Max.
-10 °C / +110 °C



PN 6:6 bar / 0.6 MPa
PN 10:10 bar / 1.0 MPa
PN 16:16 bar / 1.6 MPa



Min. / Max.
0 °C / +40 °C



< 55 dB(A)



Max. 95 % RH
IPX4D



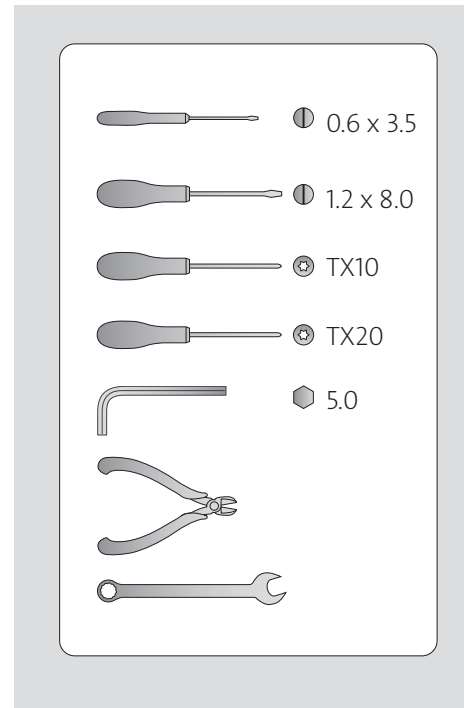
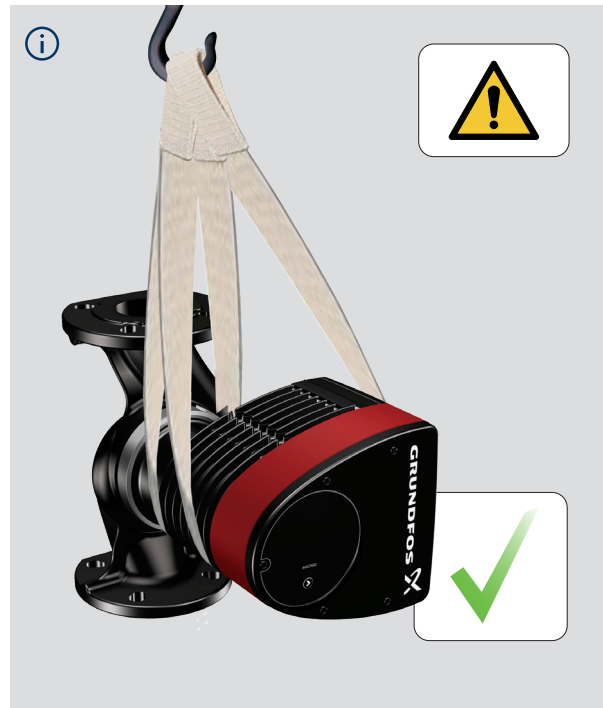

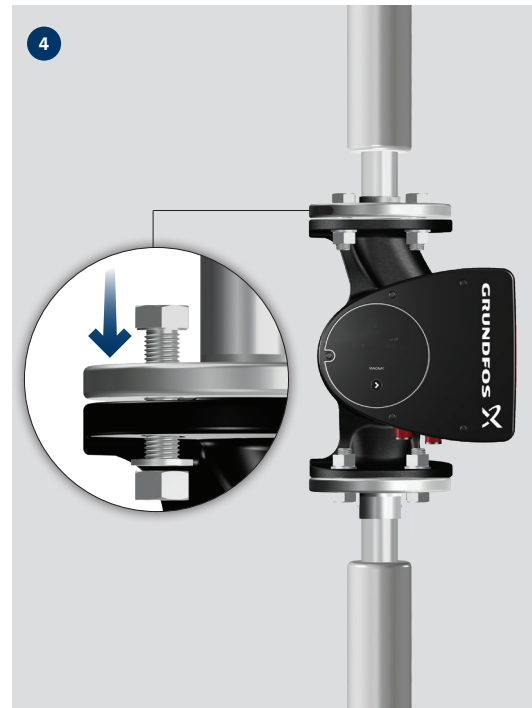

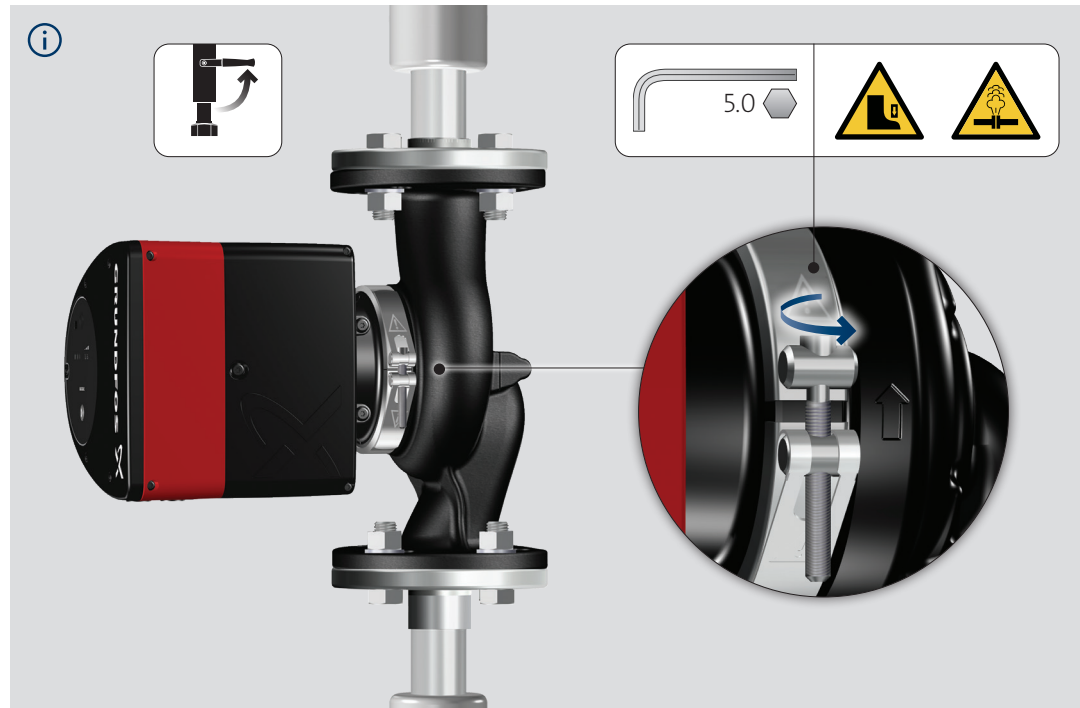

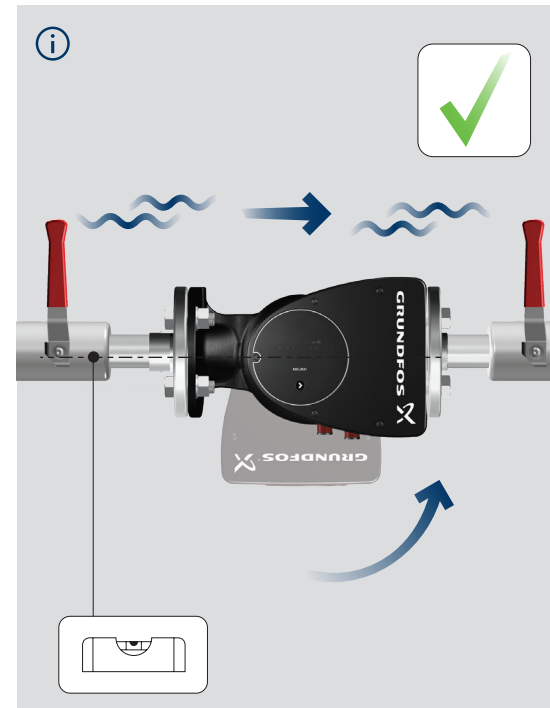
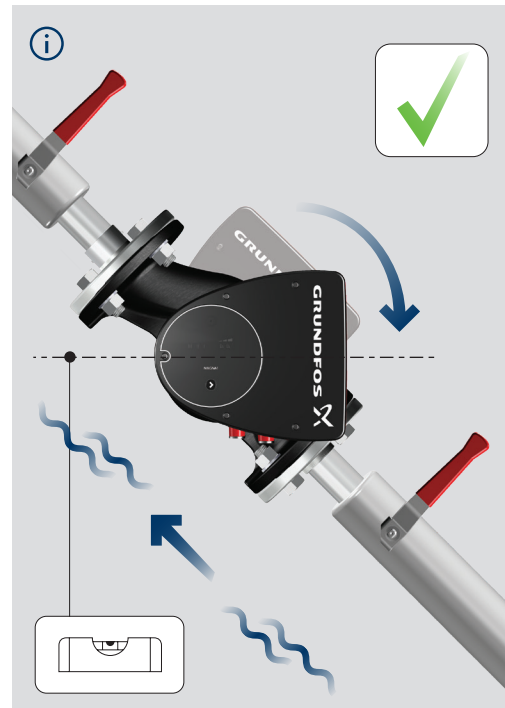
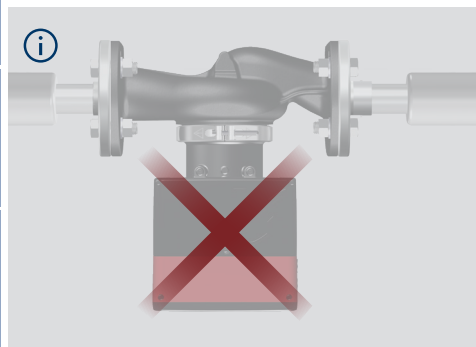
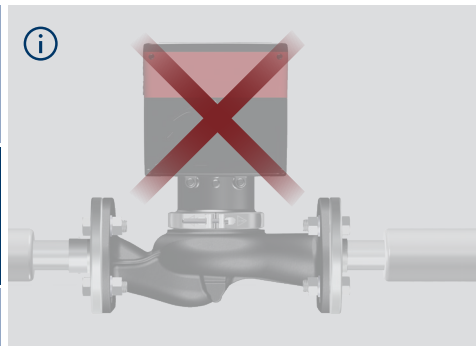

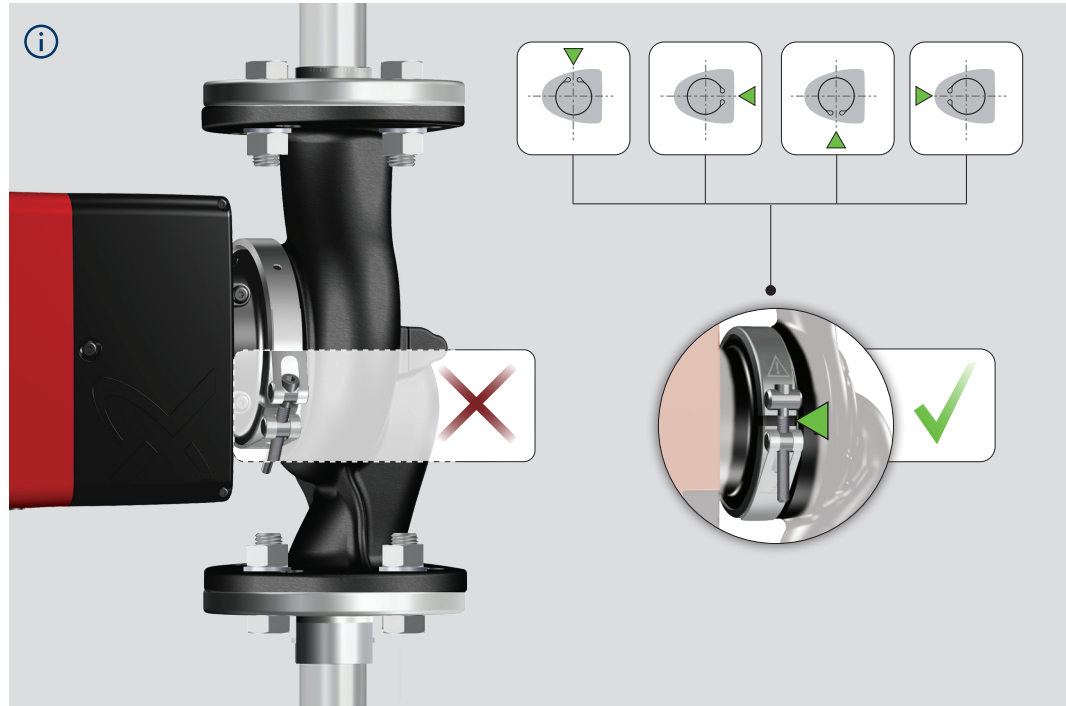
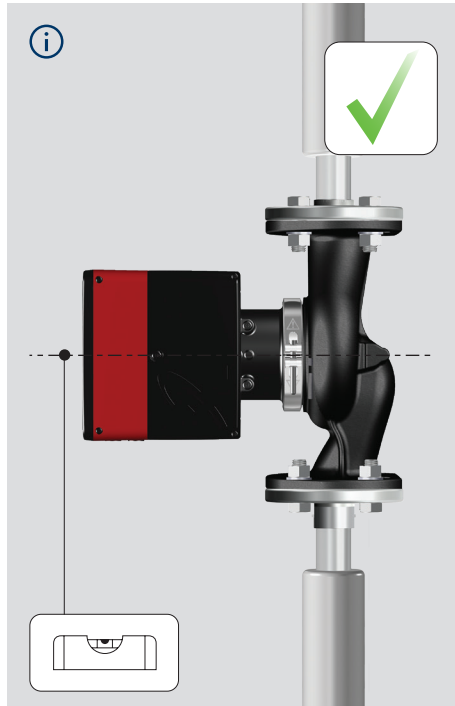
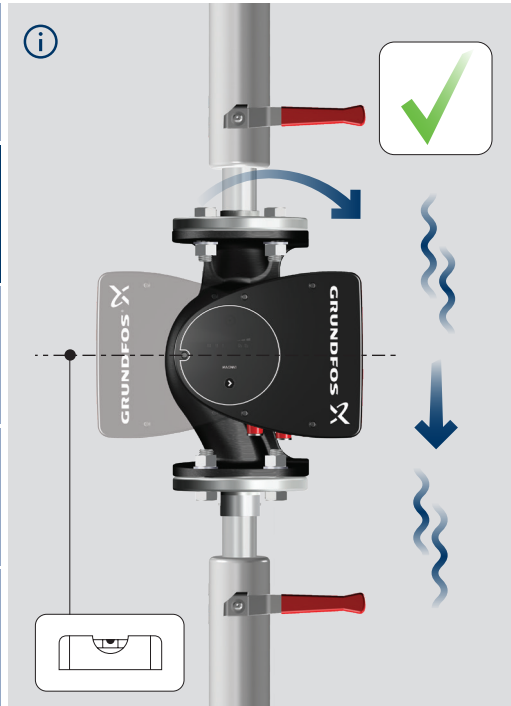

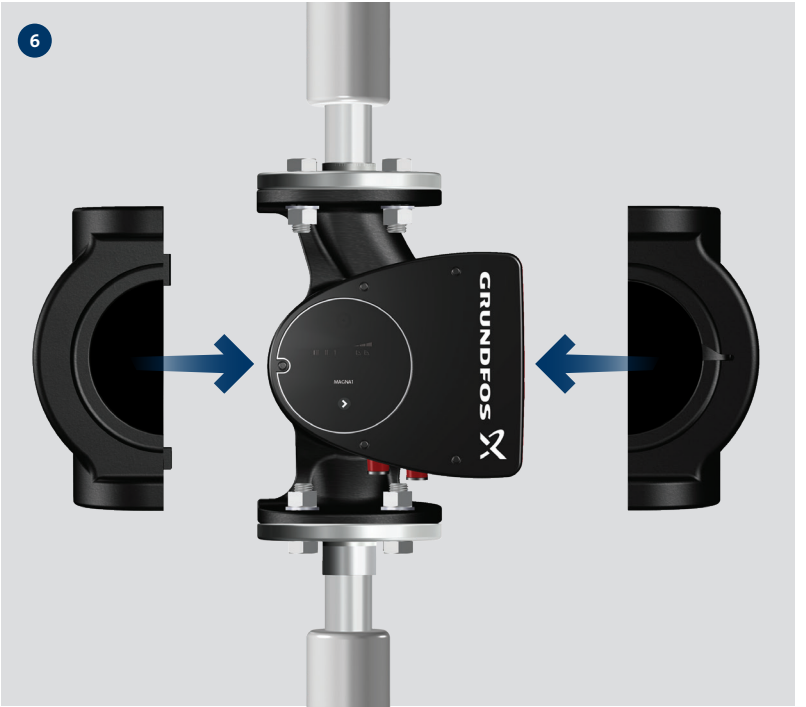
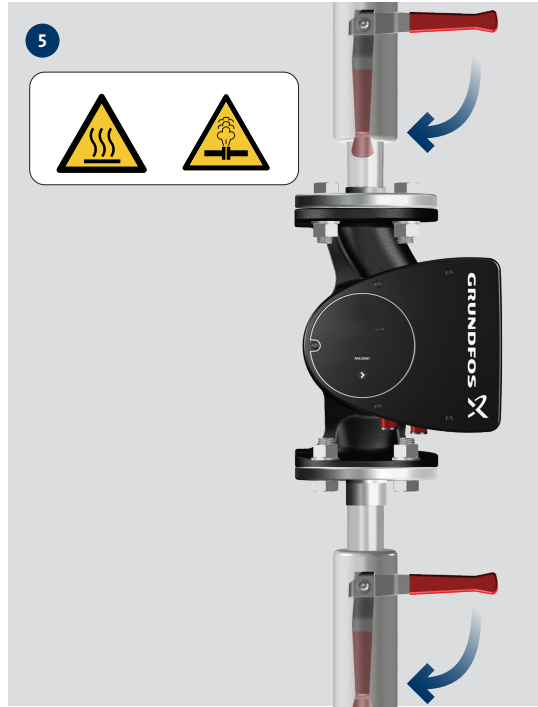



7

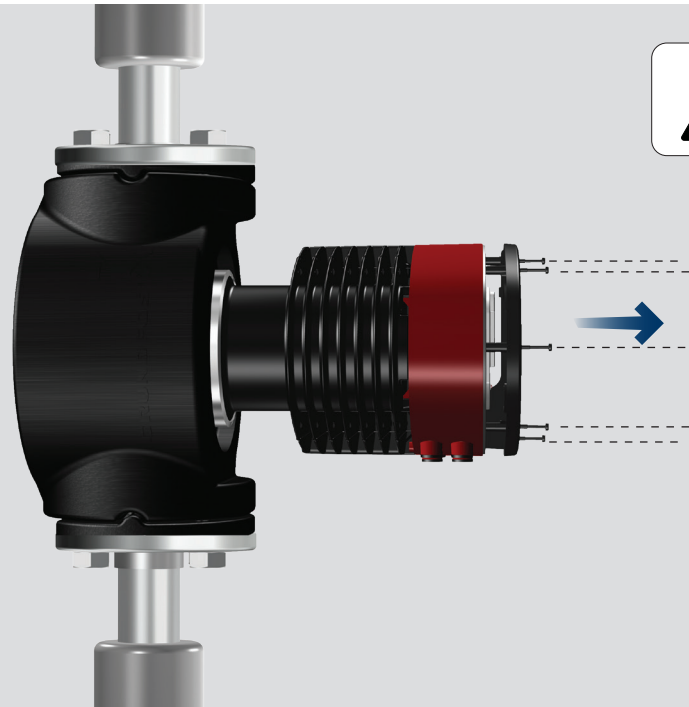

8

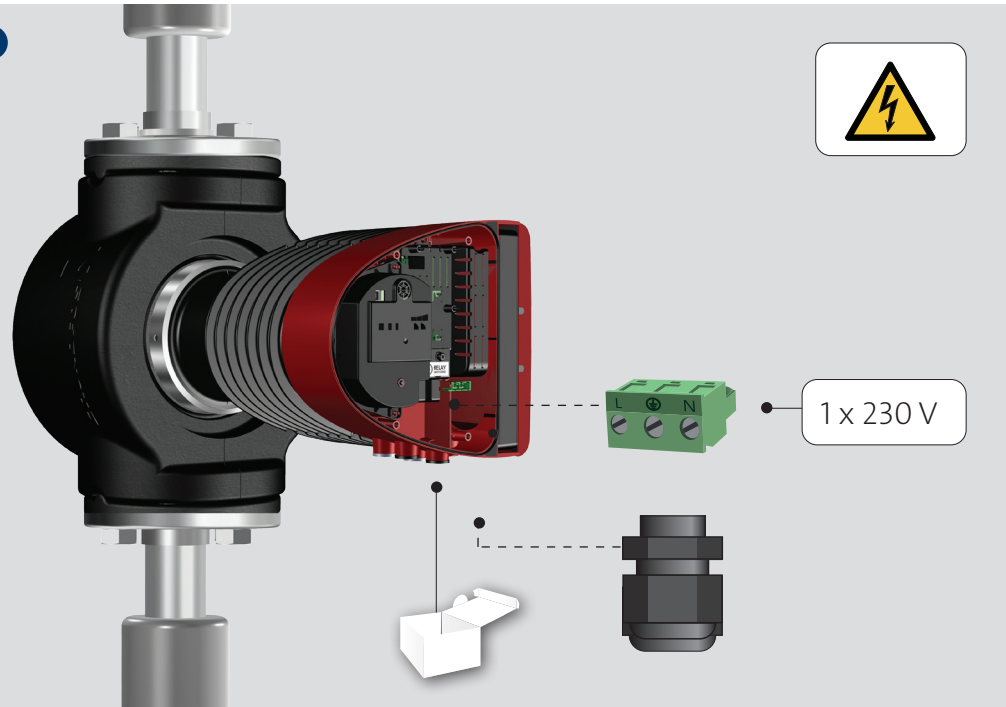

1 x 230 V

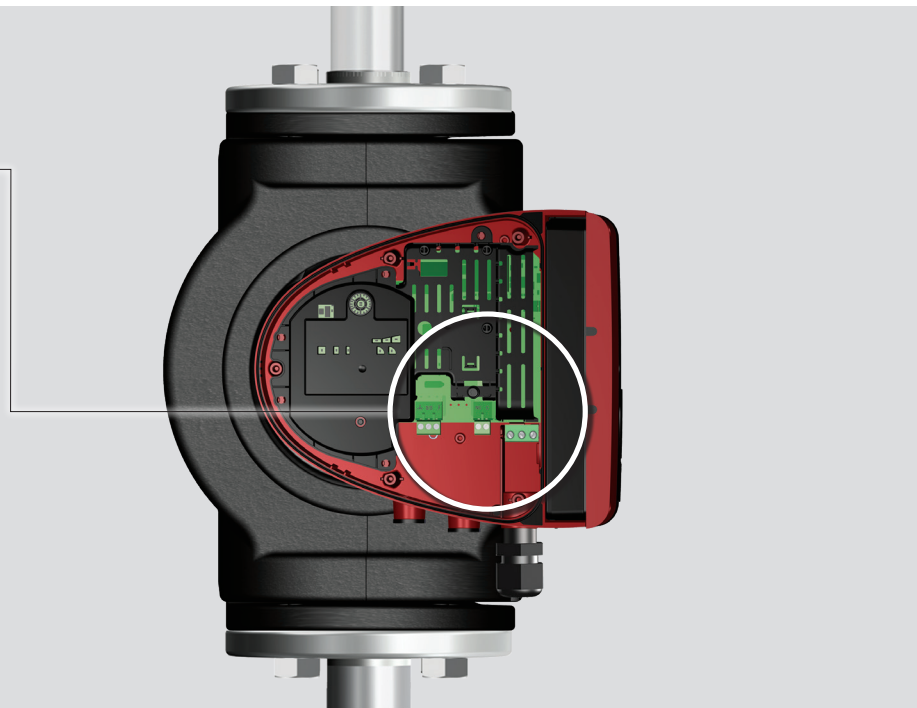
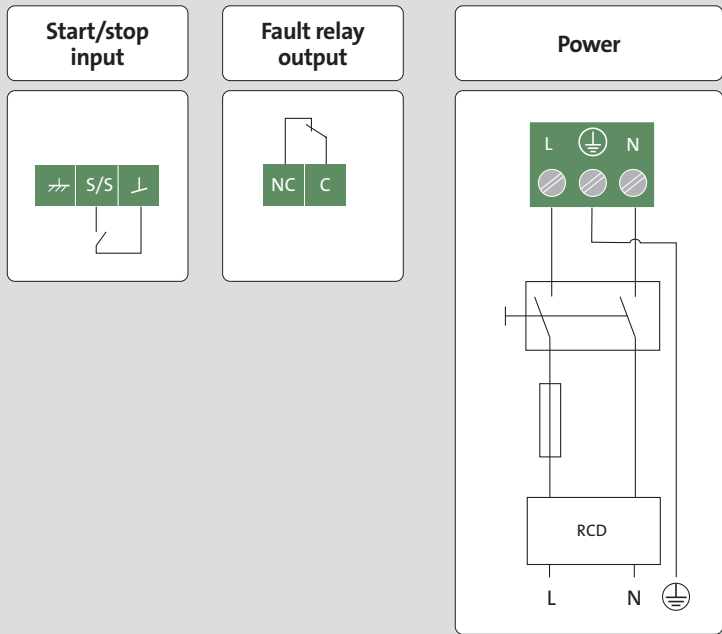

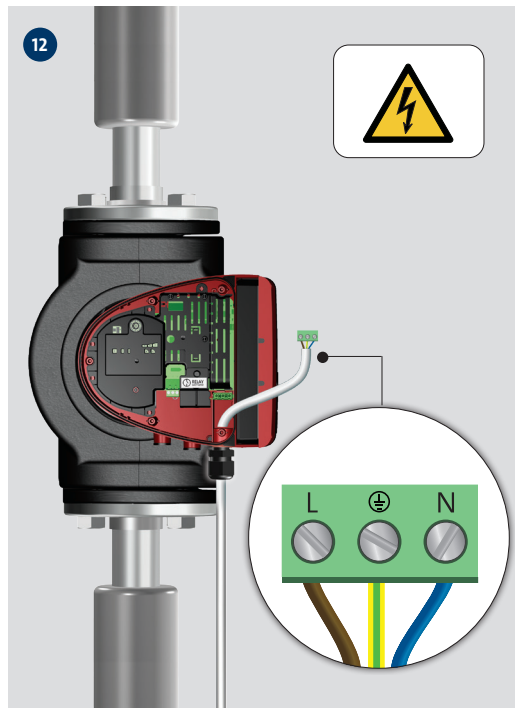
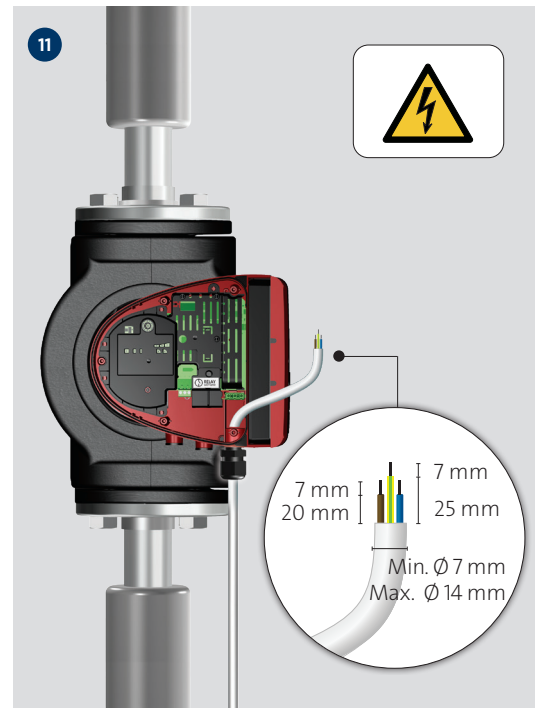
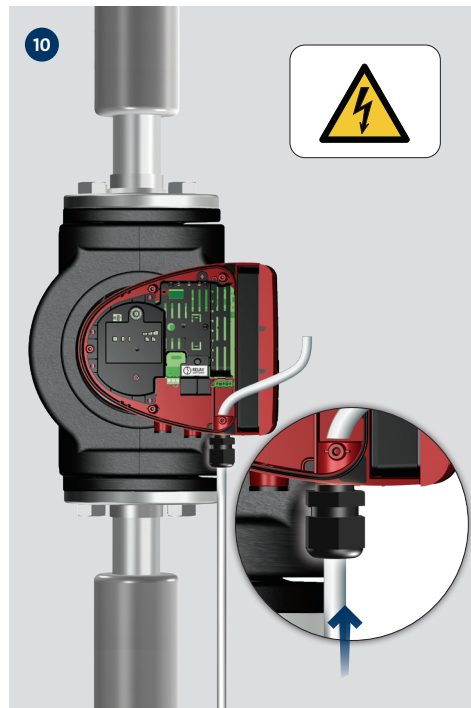
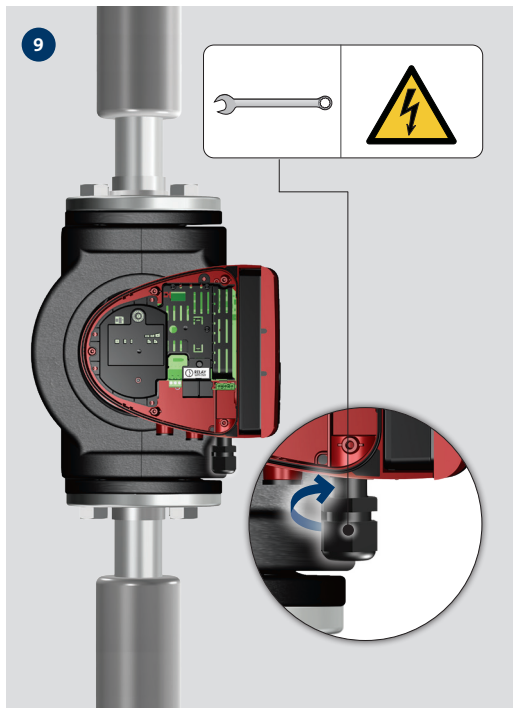



13

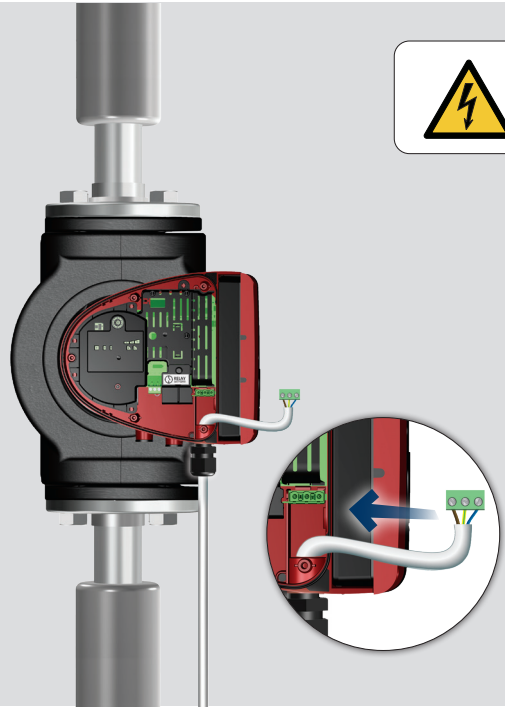

14

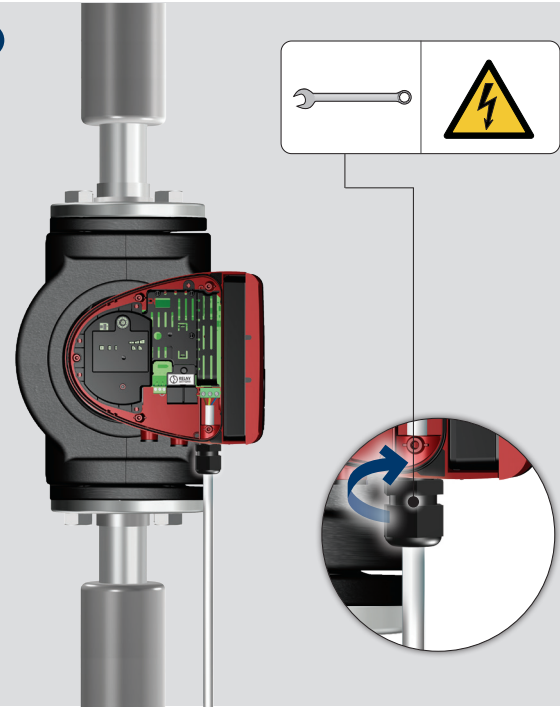
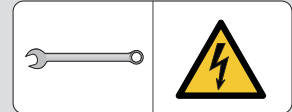

15

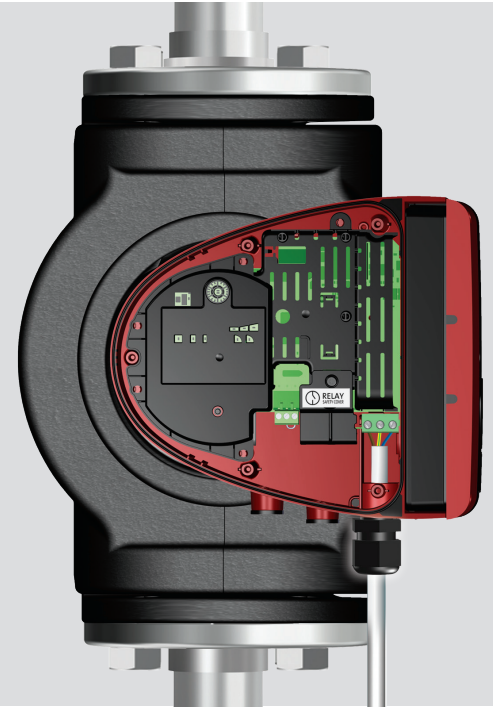

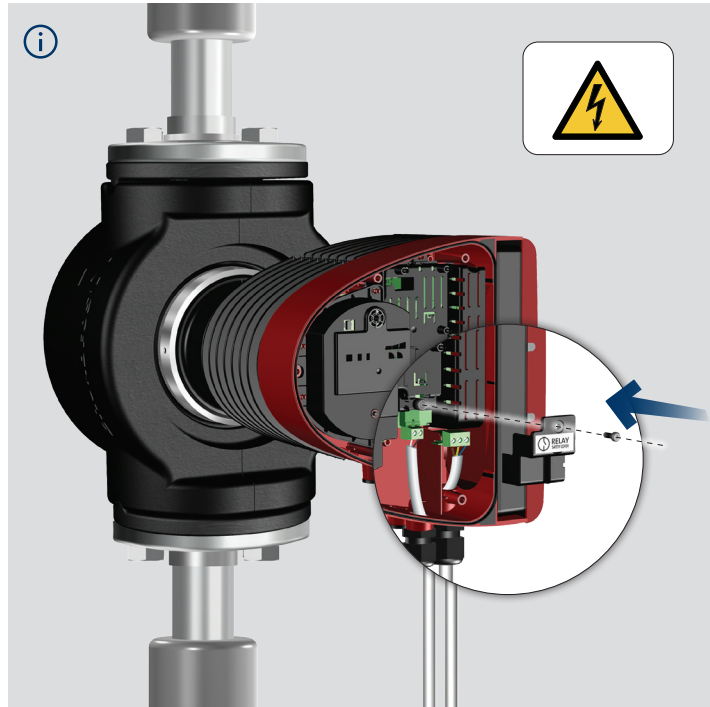
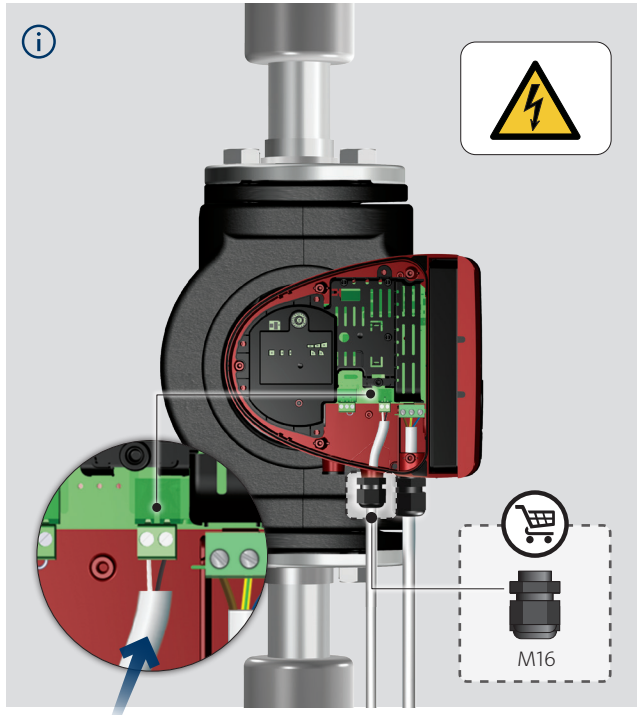
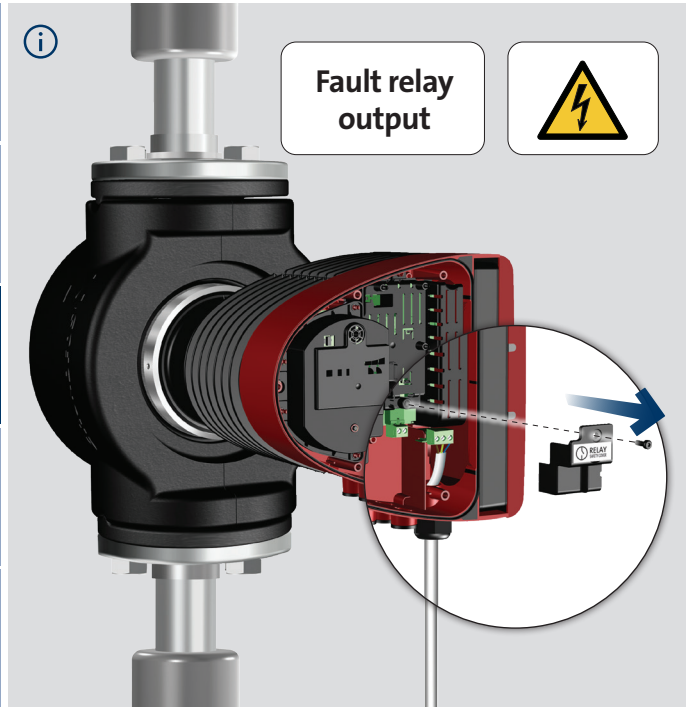

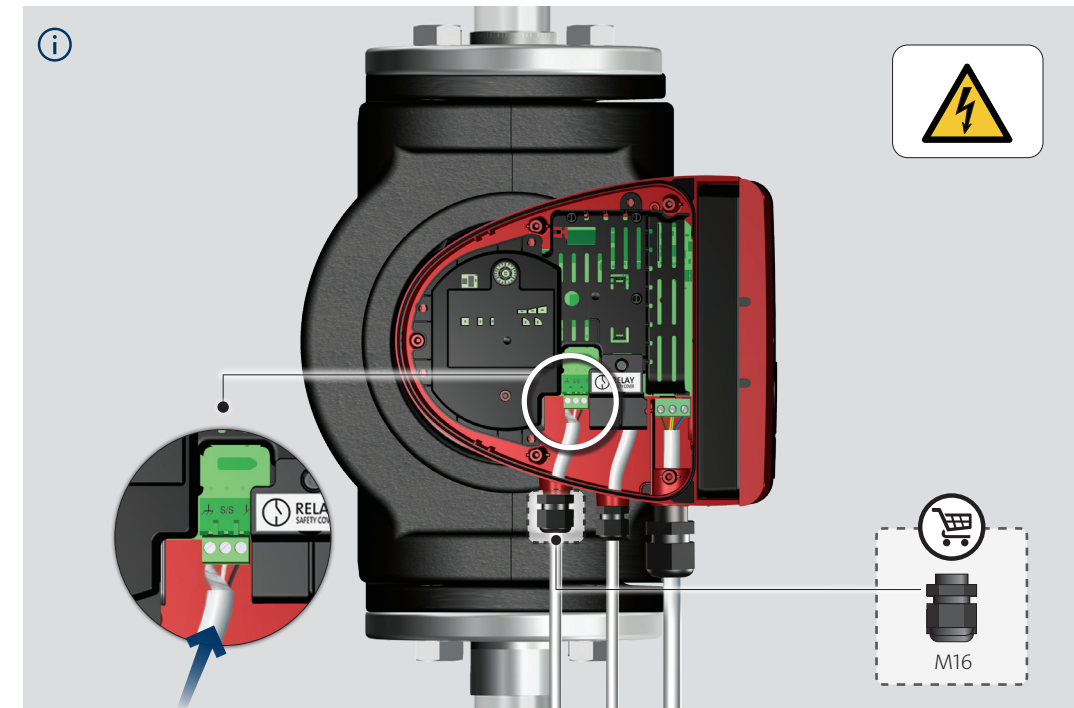
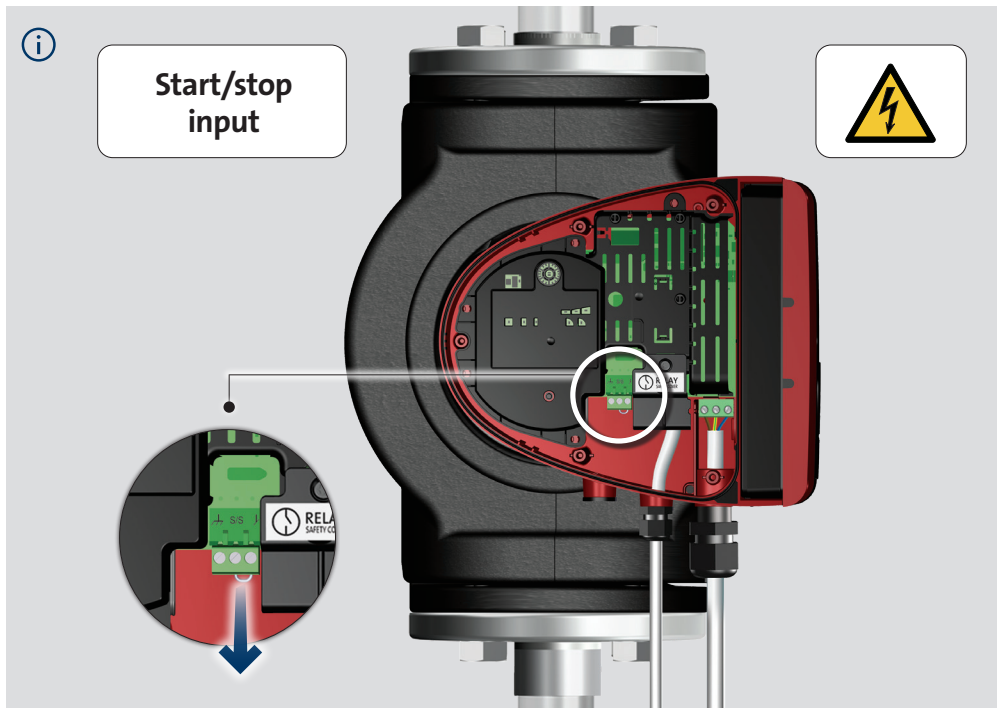



16

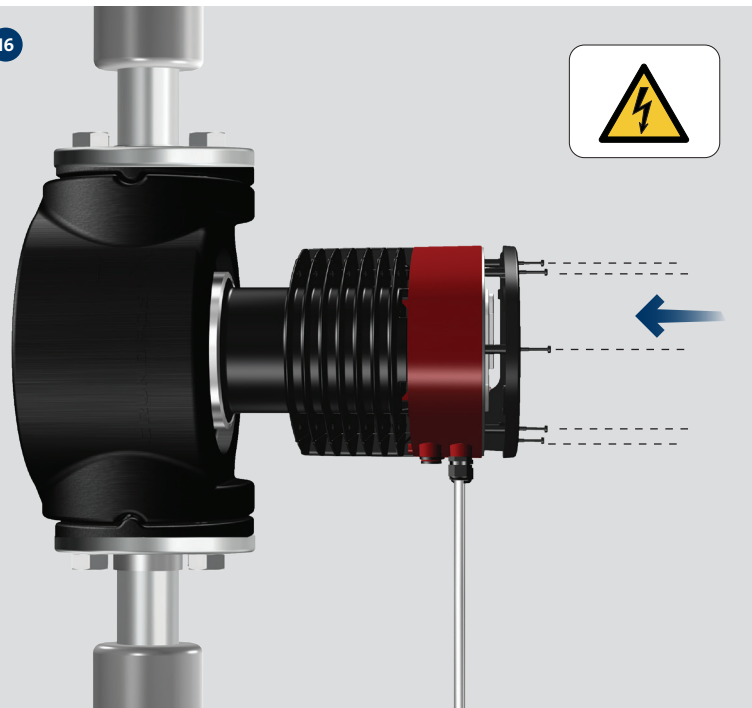

17



i

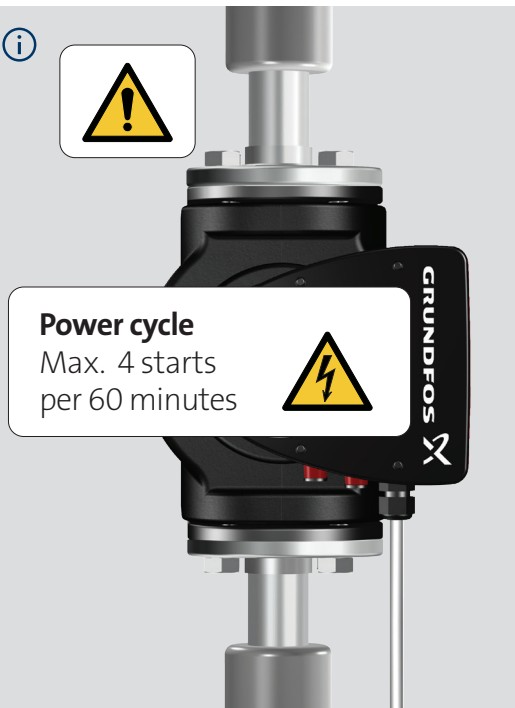



i

IR



IR

IR

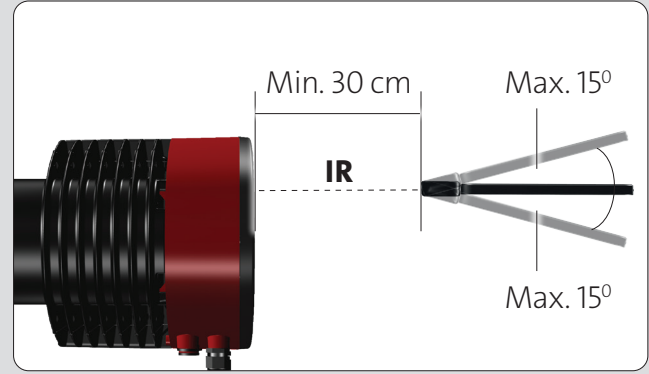
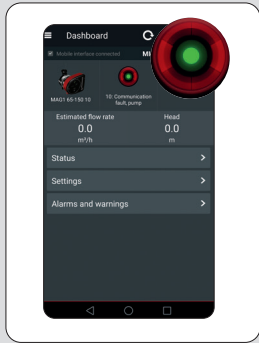

net.grundfos.com/qr/i/99209952

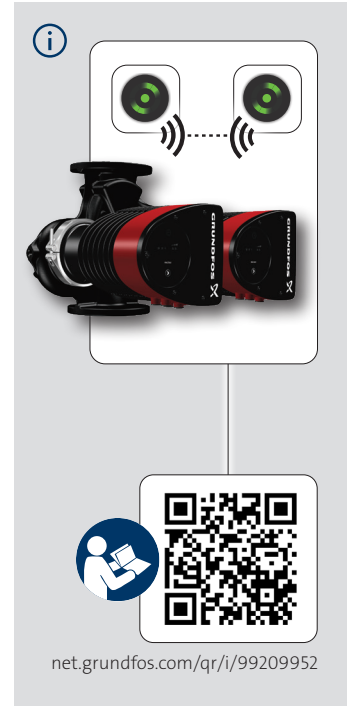
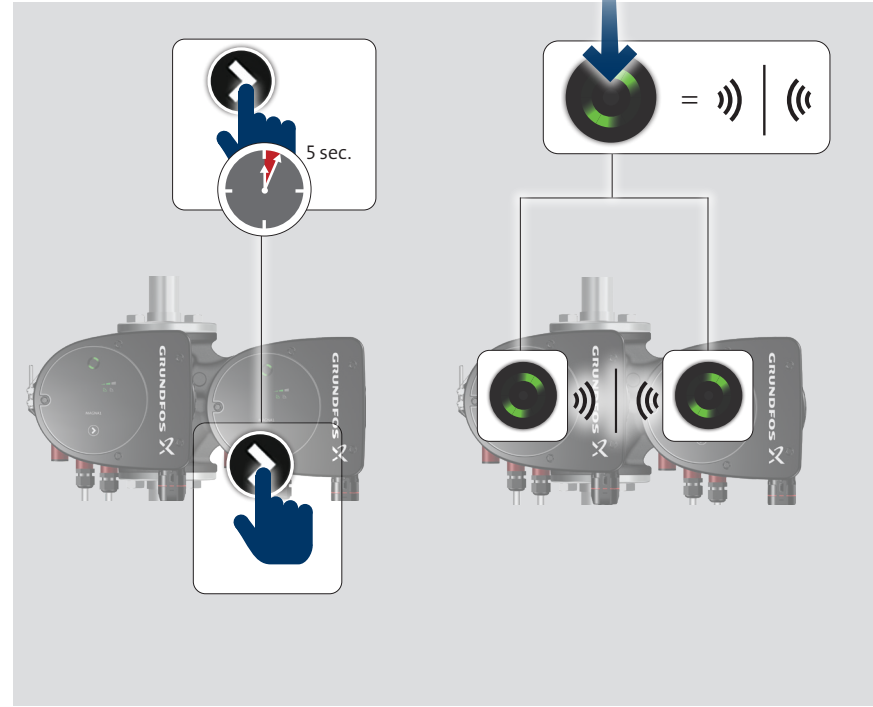
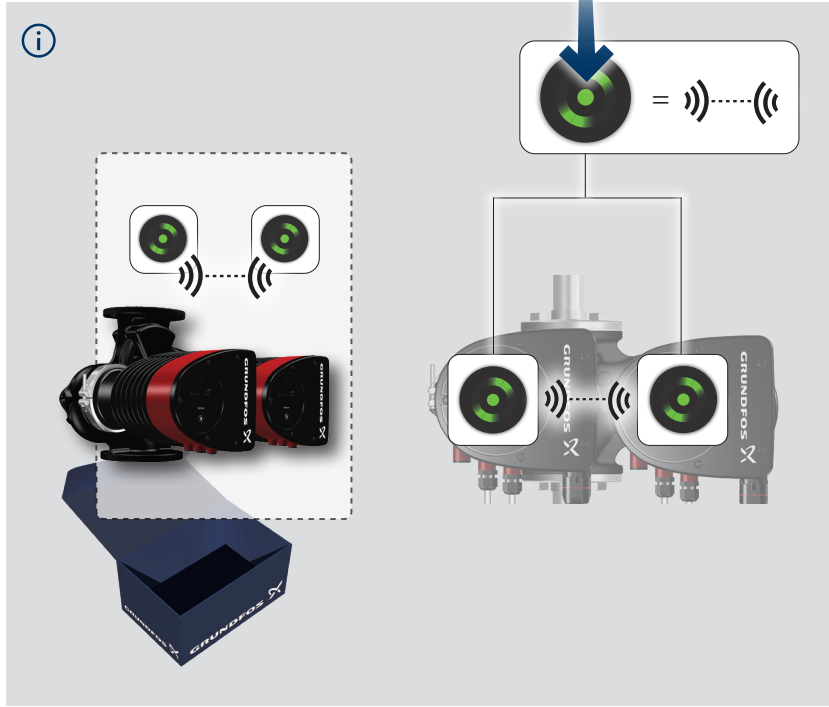

Installation date: _____

Installer:

99210934 01.2021

ECM: 1310404