

26. DW (APB)

50 Hz

Cable

Pump type	1-phase		3-phase							
	DW.50.07		DW.50.08	DW.65.27	DW.100.66H	DW.100.110H		DW.100.200H		
Pos.	DW.50.08		DW.50.09	DW.65.39H	DW.100.66	DW.150.110		DW.150.200		
	No plug	Schuko plug		DW.100.39		For external control box		For external control box		
Description/ Kit No	97524480	96943648	97524527	97524493	97524494	97524495	96913693	97524496	96913693	
23	Rubber plug	-	-	-	2	2	2	-	2	-
75	Washer	-	-	-	1	1	1	2	1	2
76	Rubber bush	-	-	-	1	1	1	2	1	2
77	Washer	-	-	-	-	1	1	2	1	2
80	Cable entry	1	1	1	1	1	1	1	1	1
81	Screw	2	2	2	2	2	2	4	2	4
82	Clamp	1	1	1	1	1	1	2	1	2
85	Motor cable	1	1	1	1	1	1	2	1	2
102	Screw	-	-	-	2	2	2	2	2	2
107	Washer	1	1	1	-	-	-	1	-	1
108	Rubber bush	1	1	1	-	-	-	1	-	1
109	Cable entry	-	-	-	-	-	-	1	-	1
109a	Clamp	-	-	-	-	-	-	1	-	1
109b	Screw	-	-	-	-	-	-	2	-	2
110	Cable sleeve	1	1	1	-	-	-	1	-	1
111	Nut for cable clamp	-	-	-	-	-	-	2	-	2
113	Motor cable	-	-	-	-	-	-	1	-	1
167	O-ring	-	-	-	-	-	-	2	-	2

Cable entry

Pump type	DW.50.07	DW.65.27	DW.100.66	DW.100.110H		DW.100.200H		
	DW.50.08	DW.65.39.H	DW.100.66H	DW.150.110		DW.150.200		
Pos.	DW.50.09	DW.100.39		3-phase, for external control box		3-phase, for external control box		
	Description/ Kit No	96945356	96945359	96945372	96945373	96945376	96945375	96945376
23	Rubber plug	-	2	2	2	-	2	-
75	Washer	-	2	1	1	2	1	2
76	Rubber bush	-	1	1	1	2	1	2
77	Washer	-	-	1	1	2	1	2
80	Cable entry	1	1	1	1	1	1	1
81	Screw	2	2	2	2	4	2	4
82	Clamp	1	1	1	1	2	1	2
102	Screw	-	2	2	2	2	2	2
107	Washer	1	-	-	-	1	-	1
108	Rubber bush	1	-	-	-	1	-	1
109	Cable entry	-	-	-	-	1	-	1
109a	Clamp	-	-	-	-	1	-	1
109b	Screw	-	-	-	-	2	-	2
110	Cable sleeve	1	-	-	-	1	-	1
111	Nut for cable clamp	-	-	-	-	2	-	2
167	O-ring	-	-	-	-	2	-	2

Discharge port, hose connection

Pos.	Pump type	DW.50.08	DW.50.07	DW.65.27	DW.100.39	DW.100.66	DW.100.110H	DW.150.110
			DW.50.09	DW.65.39.H		DW.100.66H	DW.100.200H	DW.150.200
		Description/Kit No	96946042	96946043	96946045	96946047	96946050	96946073
5	Lock nut	2	2	2	2	2	2	2
6	Washer	2	2	2	2	2	2	2
11	Stud bolts	2	2	2	2	2	2	2
57	Gasket	1	1	1	1	1	1	1
58	Discharge port	1	1	1	1	1	1	1
95	Bracket	1	-	-	-	-	-	-

Discharge port, threaded connection

Pos.	Pump type	DW.50.08	DW.50.07	DW.65.27	DW.100.39	DW.100.66	DW.100.110H	DW.150.110
			DW.50.09	DW.65.39.H		DW.100.66H	DW.100.200H	DW.150.200
		Description/Kit No	96946081	96946082	96946083	96946084	96946085	96946086
5	Lock nut	2	2	2	2	2	2	2
6	Washer	2	2	2	2	2	2	2
11	Stud bolts	2	2	2	2	2	2	2
57	Gasket	1	1	1	1	1	1	1
58	Discharge port	1	1	1	1	1	1	1
95	Bracket	1	-	-	-	-	-	-

Repair kit

Pos.	Description	Pump type					
		DW.50.08	DW.50.07	DW.65.27	DW.100.66	DW.100.110.H	DW.100.200.H
			DW.50.09	DW.65.39.H	DW.100.66.H	DW.150.110	DW.150.200
		Kit No	96957018	96957020	96957032	96957033	96957035
16	O-ring	-	2	2	-	-	-
31	Seal ring	-	3	3	3	3	3
32	O-ring	-	1	1	1	1	1
34	O-ring	1	3	5	5	4	4
35	O-ring	-	1	1	1	1	1
39	O-ring	-	-	1	1	1	1
40	Seal ring	-	1	1	1	1	1
41	Retaining ring	1	1	1	1	1	1
42	Washer	-	-	-	-	1	1
44	Washer	-	-	-	-	1	1
45	Seal washer	-	3	3	3	5	5
49	O-ring	1	2	2	2	1	2
50	O-ring	-	-	-	-	-	1
51	O-ring	2	-	-	-	1	2
55	O-ring	1	1	1	1	1	1
57	Gasket/O-ring	1	1	1	1	1	1
61	O-ring	-	-	-	-	1	1
66	O-ring	-	1	1	1	1	1
68	Rubber cap	-	1	1	1	1	1
72	Valve rubber	-	1	1	1	1	1
76	Rubber bush	-	-	1	1	2	1
76	Rubber bush	-	-	-	-	-	2
78	O-ring	-	2	2	2	2	2
82	Clamp	1	1	1	1	2	2
83	O-ring	-	2	2	2	2	2
86	Valve cap	-	1	1	1	1	1
87	Bow	-	-	-	-	1	1
105	Retaining ring	-	-	-	-	1	1
108	Rubber bush	1	1	-	-	1	1
110	Cable sleeve	1	1	-	-	-	-
114	Seal washer	-	1	1	1	-	-
119	Key	-	-	-	2	-	-
128	Retaining ring	-	1	-	-	-	-
136	Pipe plug	1	-	-	-	-	-
139	Rubber gasket	1	-	-	-	-	-
142	Cable sleeve	1	-	-	-	-	-
146	Rubber bush	1	-	-	-	-	-
147	Grease nipple	1	-	-	-	-	-
148	Cover	1	-	-	-	-	-
150	O-ring	1	-	-	-	-	-
167	O-ring	-	-	-	-	2	2

Impeller

Pos.	Pump type	DW.50.08	DW.50.07	DW.50.09	DW.65.27	DW.65.39.H	DW.100.39
	Description/ Kit No	97524525	97524500	97524511	97524512	97524514	97524515
12	Impeller screw rubber plug	-	1	1	1	1	1
14	Impeller screw	-	1	1	1	1	1
15	Washer	-	1	1	1	1	1
16	O-rings	-	2	2	2	2	2
18	Impeller	1	1	1	1	1	1
18	Impeller	-	-	-	-	-	-
21	Split bush, long, split cone	-	1	1	1	1	1
119	Key	-	-	-	-	-	-
119	Key	-	-	-	-	-	-
121	Impeller nut	2	-	-	-	-	-
165	Disc	-	-	-	-	-	-

Pos.	Pump type	DW.100.66	DW.100.66H	DW.100.110H	DW.150.110	DW.100.200H	DW.150.200
	Description/Kit No	97524519	97524521	97524498	97524522	97524499	97524524
12	Impeller screw rubber plug	-	-	1	1	1	1
14	Impeller screw	-	-	1	1	1	1
15	Washer	1	1	1	1	1	1
16	Spacer	-	2	-	-	-	-
17	Split bush, short	-	-	1	-	1	-
18	Impeller	1	1	1	1	1	1
18	Impeller	-	1	1	-	1	-
21	Split bush, long, split cone	-	-	1	1	1	1
119	Key	1	1	-	-	-	-
119	Key	-	1	-	-	-	-
121	Impeller nut	1	1	-	-	-	-
165	Disc	2	2	-	-	-	-

Shaft seal

Pos.	Pump type	DW.50.08	DW.50.07	DW.65.27	DW.100.110H
			DW.50.09	DW.65.39.H	DW.150.110
				DW.100.39	DW.100.200H
				DW.100.66	DW.150.200
				DW.100.66H	
	Description/Kit No	96956225	96956226	96956227	96956228
31	Fibre ring	-	3	3	3
34	O-rings	1	1	1	1
37	Primary shaft seal	1	1	1	1
39	O-ring	-	-	1	1
40	Seal ring	-	1	1	-
45	Washer	-	-	-	2
103	Lower shaft seal	-	-	-	1
105	Retaining ring	-	-	-	1
114	Seal washer	-	1	1	-
132	Spacer	4	-	-	-
148	Cover	1	-	-	-
150	V-ring	1	-	-	-

Wear parts

Pos.	Pump type	DW.50.08	DW.50.07	DW.65.27	DW.65.39.H	DW.100.39
		DW.50.09				
Description/Kit No		96956242	96956243	96956244	96956245	96956246
19	Diffuser	1	1	1	1	1
28	Impeller disc	1	1	1	1	1
29	Rubber lining	-	1	1	1	1
32	O-ring	-	1	1	1	1

Pos.	Pump type	DW.100.66	DW.100.66H	DW.100.110H	DW.150.110	DW.100.200H	DW.150.200
		DW.100.66H					
Description/Kit No		96956247	96956248	96956249	96956251	96956263	96956264
8	Diffuser inlet	-	-	-	-	-	1
13	Diffuser, second	-	1	1	-	1	-
19	Diffuser	1	1	1	1	1	1
22	Impeller disc, second	-	-	1	-	1	-
25	Sealing	-	-	-	-	1	-
28	Impeller disc	1	1	1	1	1	1
29	Rubber lining	1	1	1	1	1	1
32	O-ring	1	1	1	1	1	1
120	Supporting ring	-	1	-	-	-	-
168	O-ring	-	-	-	-	1	-

Electrode

Pos.	Pump type	DW.50.07
		DW.50.09
		DW.65.27
		DW.65.39.H
		DW.100.39
		DW.100.66
		DW.100.66H
		DW.100.110H
		DW.150.110
		DW.100.200H
		DW.150.200
Description/Kit No		97524477
35	O-ring (electrode seat)	1
60	Spring pin	1
66	O-ring (electrode)	1
67	Electrode unit	1
68	Rubber cap	1

Valve

Pos.	Pump type	DW.50.07	DW.65.27	DW.100.110H
		DW.50.09	DW.65.39.H	DW.150.110
		DW.100.39	DW.100.200H	
		DW.100.66	DW.150.200	
		DW.100.66H		
Description/Kit No		97524384	97524466	97524471
72	Valve rubber	1	1	1
78	O-ring	2	2	2
79	Valve body	1	1	1
86	Valve cap	1	1	1
87	Bow	-	-	1
88	Screw	-	-	1

Float switch

Pos.	Pump type	DW.50.08
		Description/Kit No
129	Holder	1
138	Washer	1
141	Level control	1
142	Cable sleeve	1
143	Cable entry unit complete	1
146	Rubber bush	1

DW.50.08

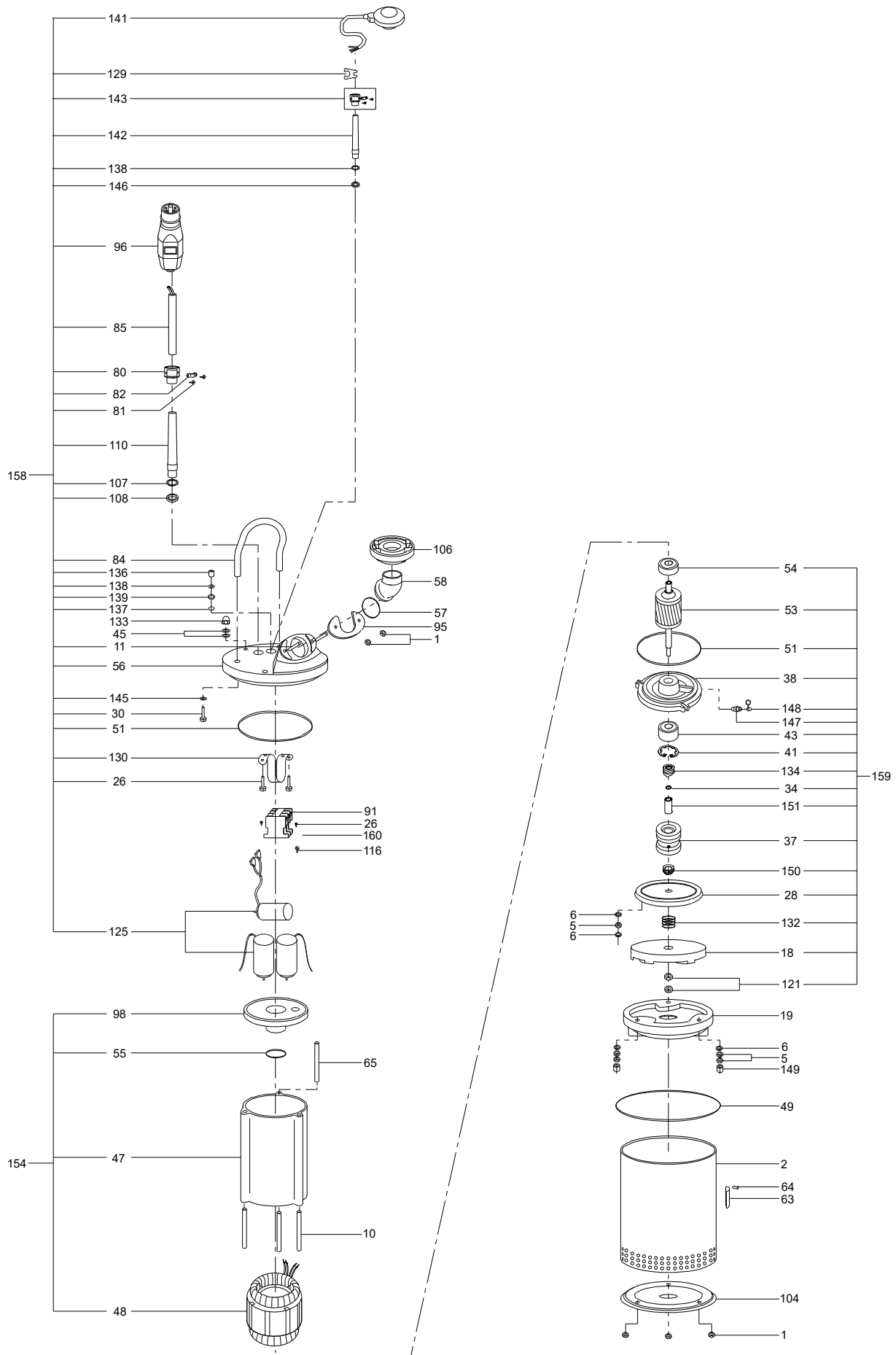

TM021861

DW.50.07/09

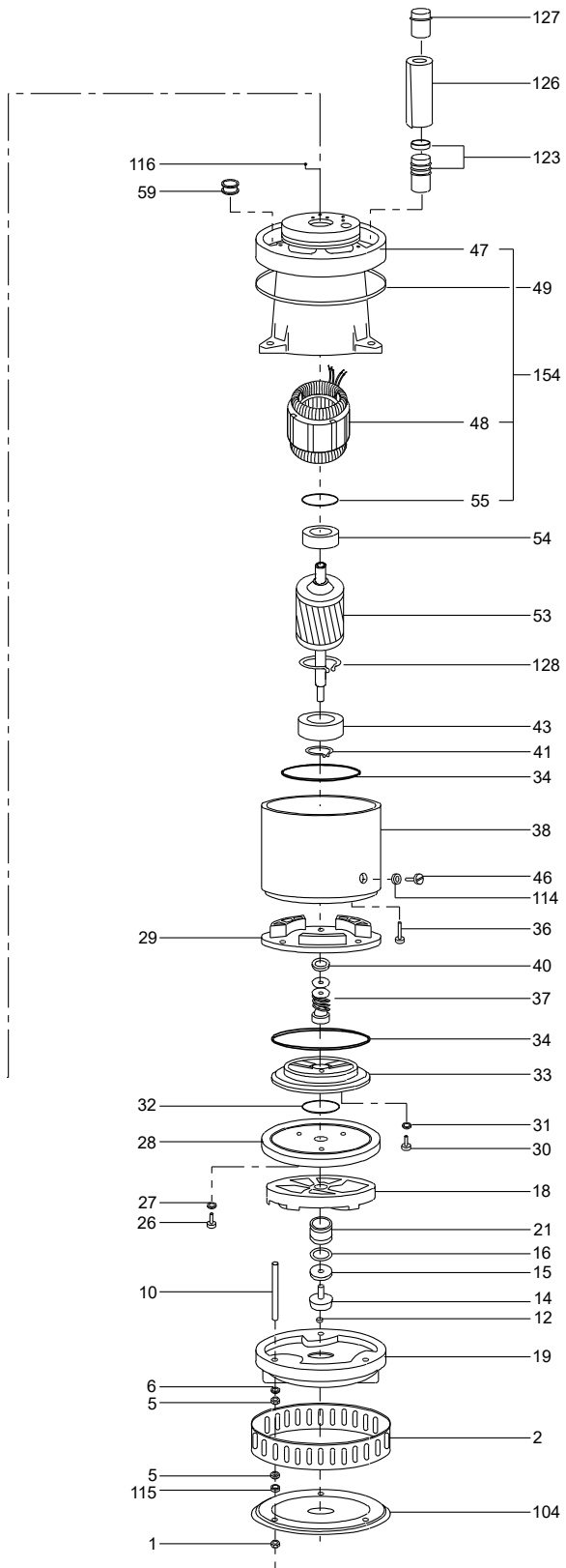
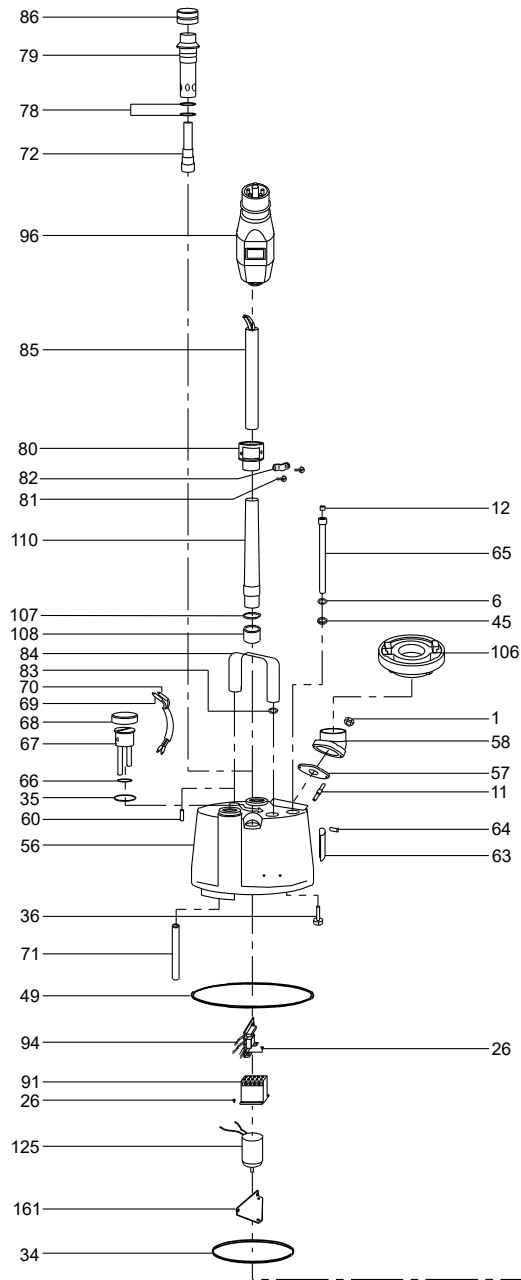

TM014535

DW.65.27

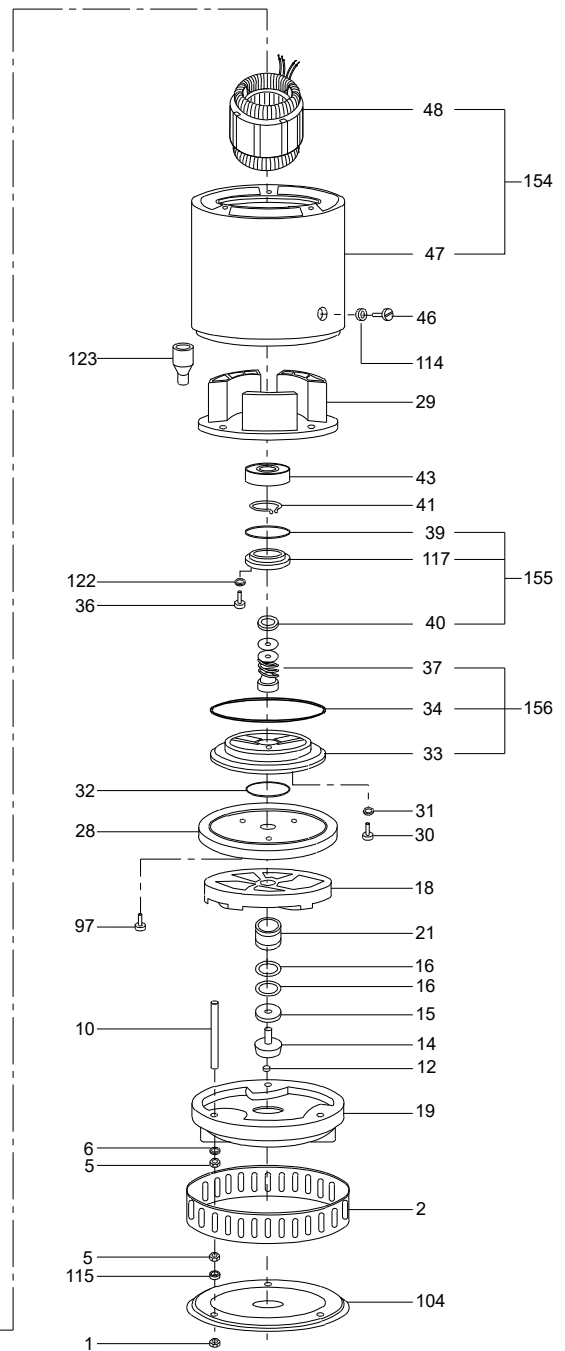
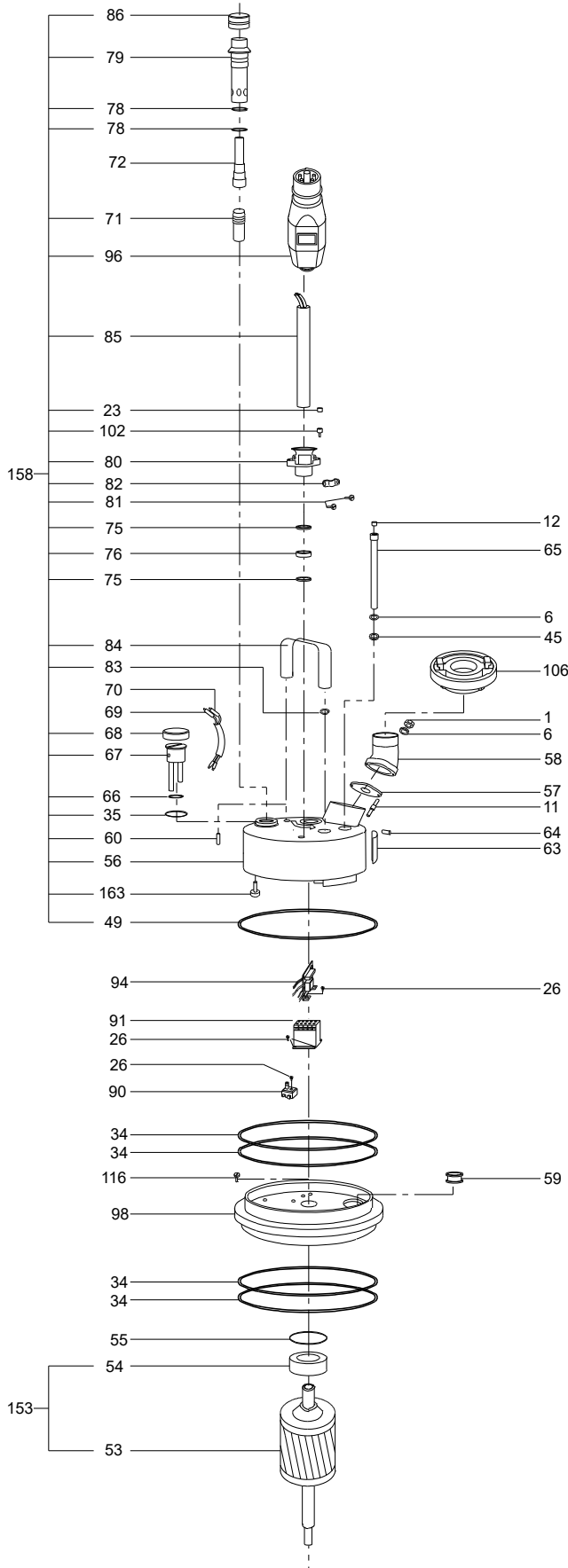

TM014536

DW.65.39H/100.39

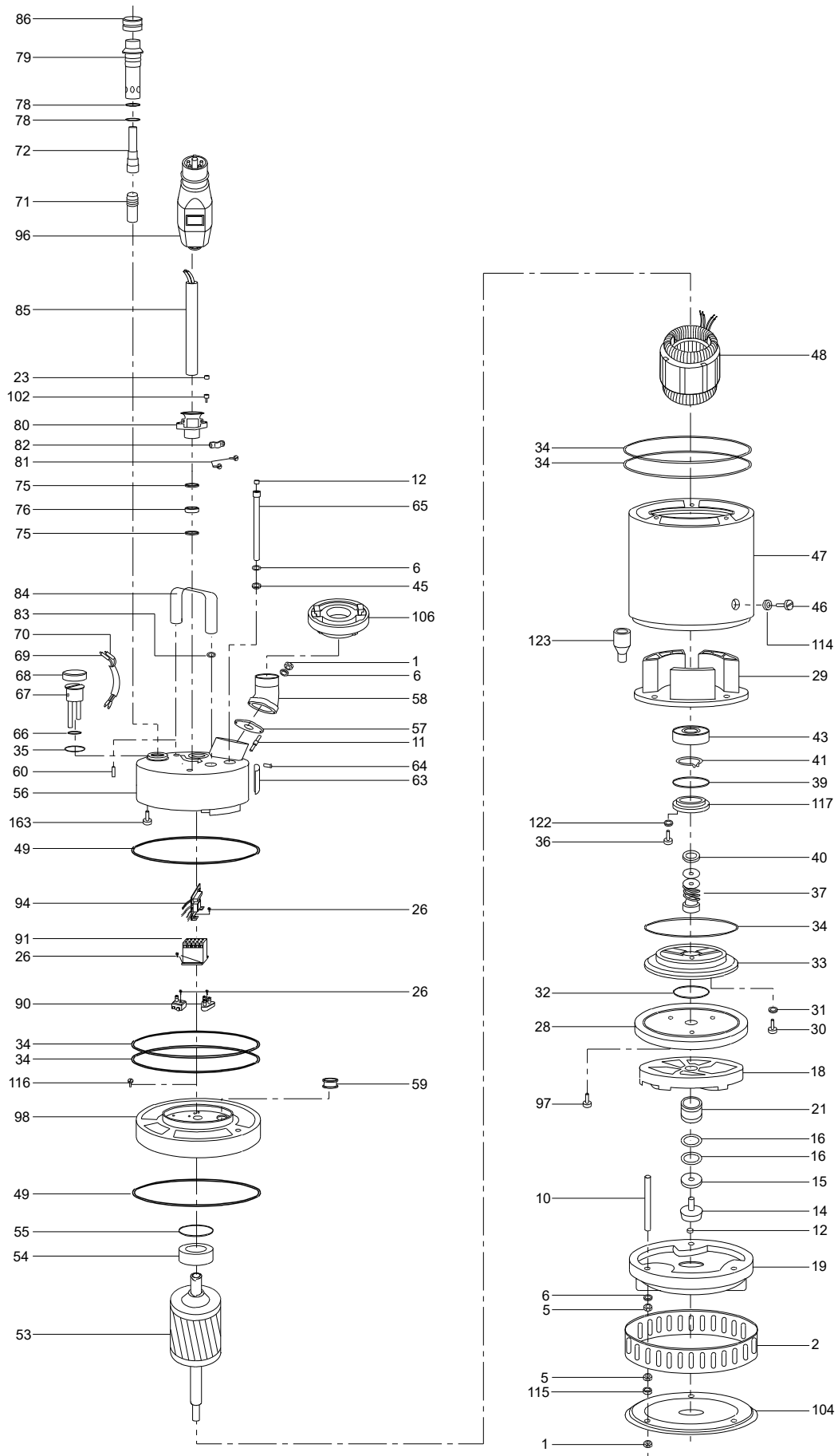

TM014540

DW.100.66 (H)

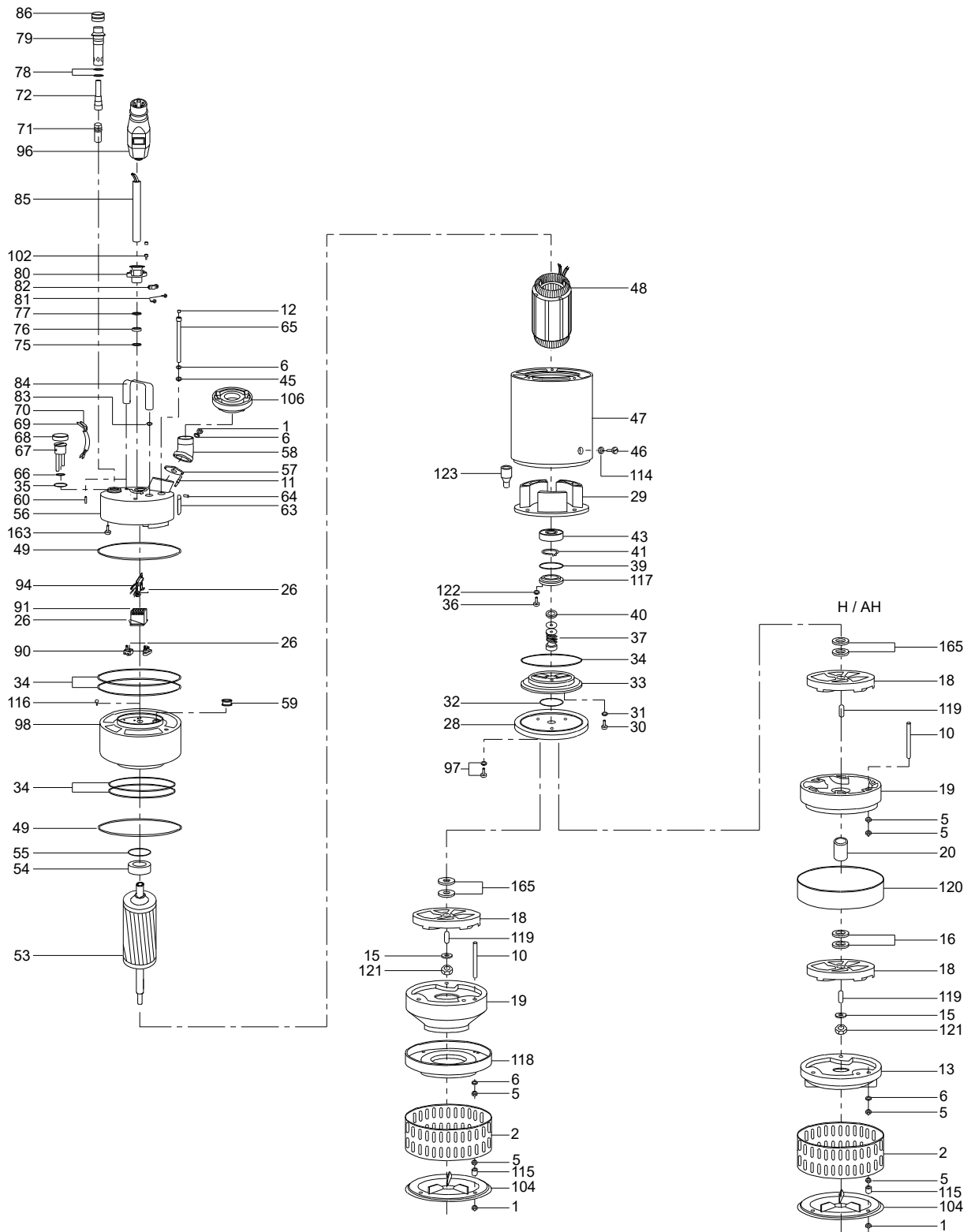

TM021862

DW.100.110H/150.110

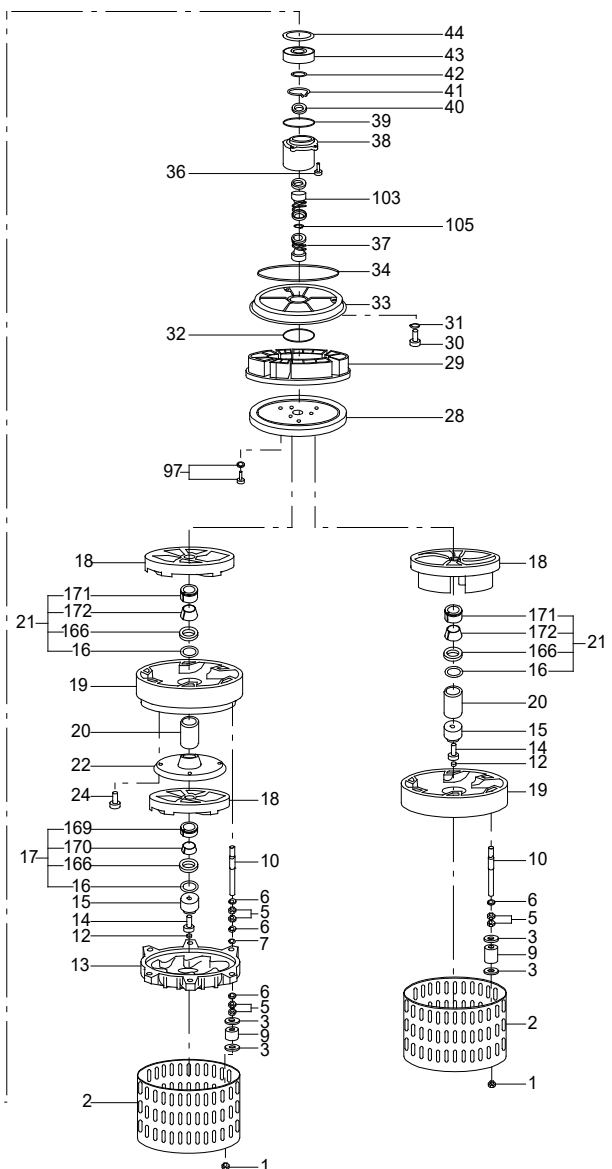
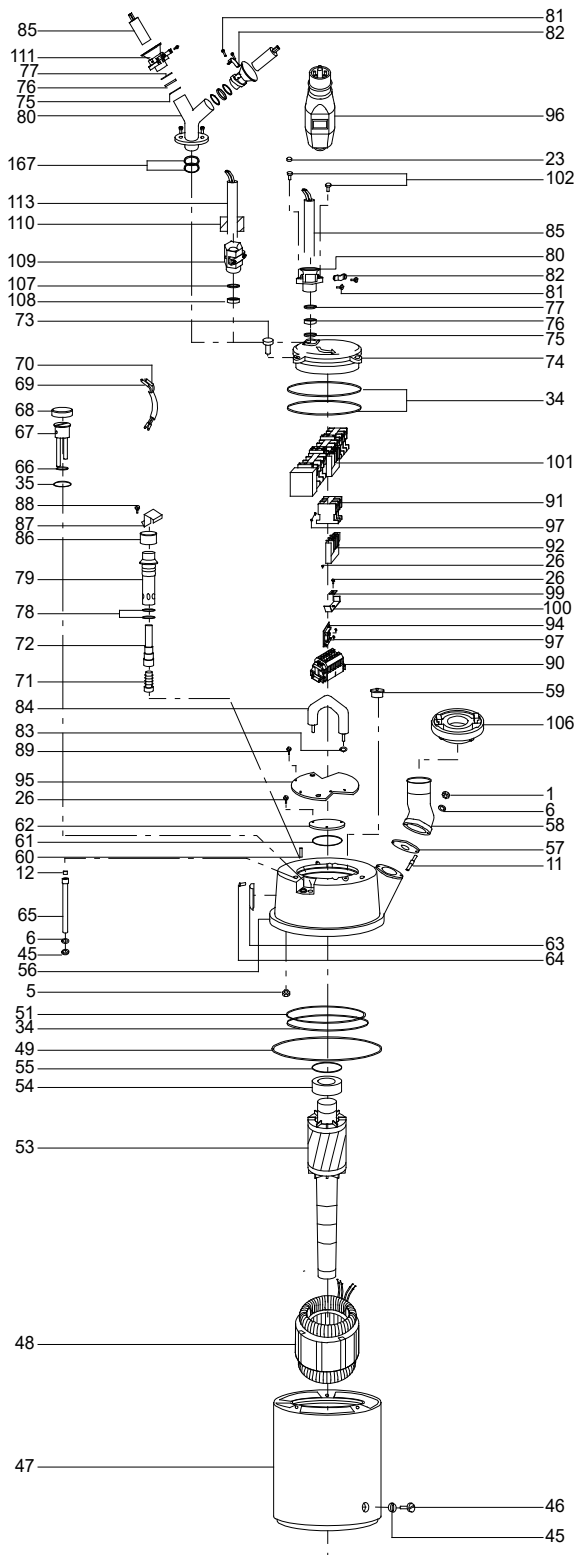

TM014538

DW.100.200H/150.200

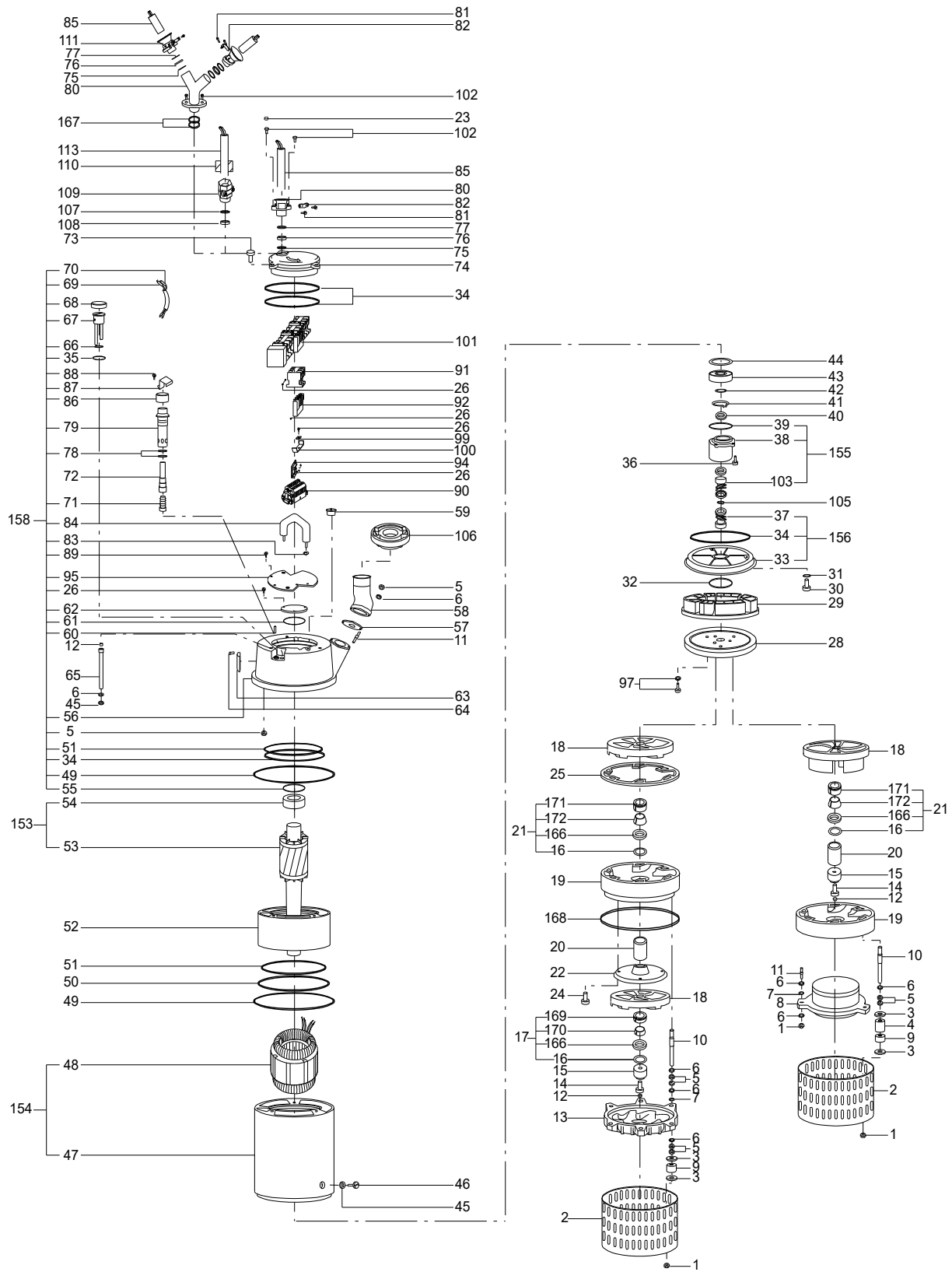

TM014537

96488862 06.2022

GRUNDFOS Holding A/S
Poul Due Jensens Vej 7
DK-8850 Bjerringbro
Tel: +45 87 50 14 00
www.grundfos.com

GRUNDFOS 